

Using the HP 3586A, B & C Selective Level Meter and HP 3336A, B & C Synthesizer/Level Generator

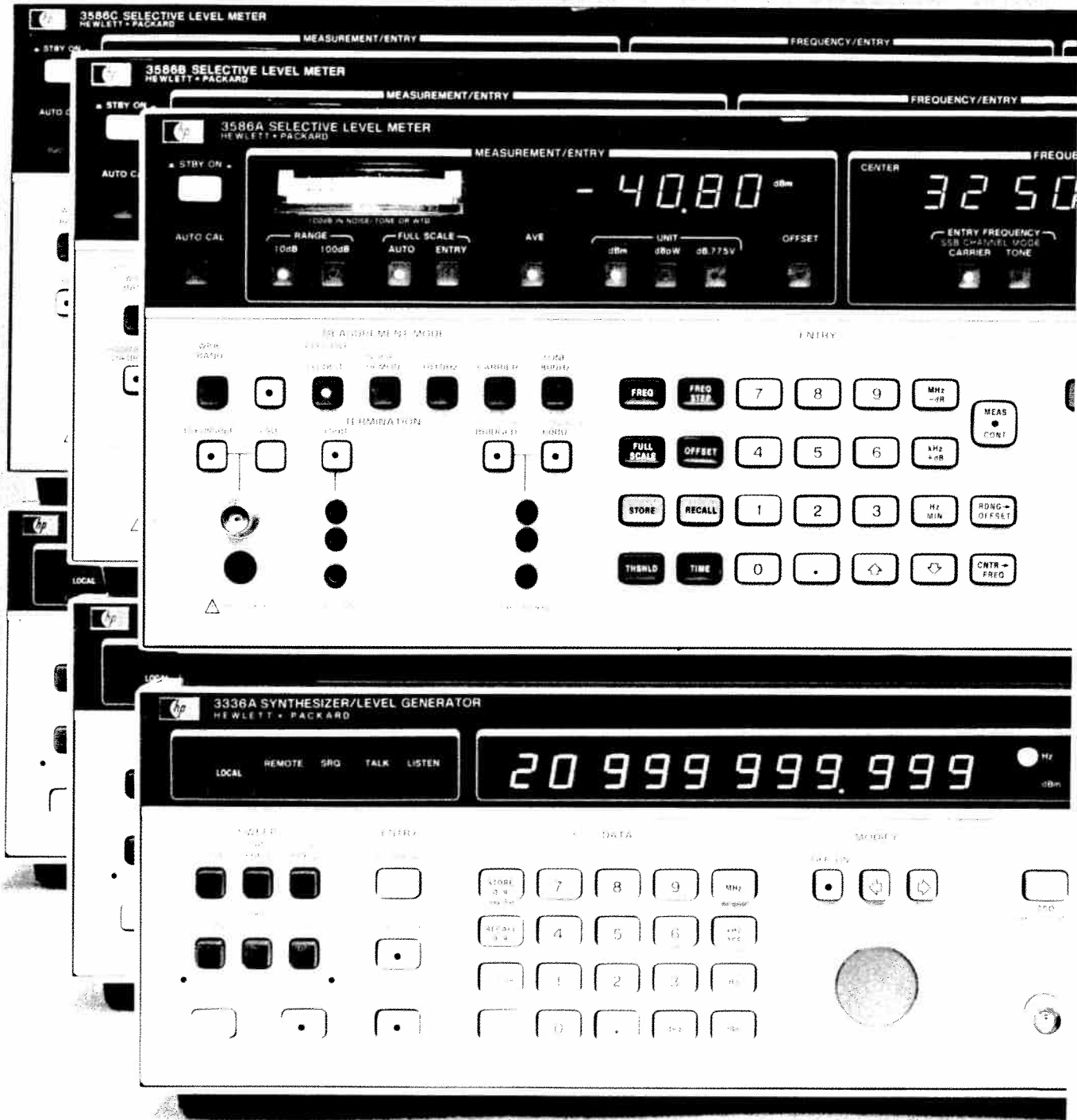

Table of Contents

Chapter I	Introduction	1
	HP Model 3586A, B & C Selective Level Meter	2
	HP Model 3336A, B & C Synthesizer / Level Generator	3
Chapter II	Front Panel Features	4
	HP 3586A, B & C SLM	4
	HP 3336A, B & C S/LG	8
Chapter III	Specification Summary	10
	HP 3586A, B & C SLM	10
	HP 3336A, B & C S/LG	10
Chapter IV	Operation and Applications	11
	HP 3586A, B & C SLM	11
	Basic Measurement Modes	11
	Selective Measurements	11
	SSB Channel Measurements	11
	SSB Measurements with the 3586C SLM	13
	Wideband Power Measurements	13
	Convenience Features	13
	General Purpose Wave Analysis	15
	Harmonic Levels	15
	Inter-modulation Products	16
	Modulation Distortion	17
	Spurious and Signals Close to the Noise	17
	Frequency Response Testing Using the Tracking Output	18
	Frequency Response Testing Using a Tracking Synthesizer	18
	Selective and Wideband Noise Measurements	18
	Return Loss	19
	Measurements on FDM Systems	20
	FDM Channel Measurements at a Keystroke	21
	Transmission Impairments Measurements with Option 003	23
	Slot Noise, Noise Power Ratio (NPR)	23
	Cross Talk Measurements	24
	HP 3336A, B & C S/LG	25
	Basic Operation	25
	Data Entry	25
	Using Modify to Tune Signal Parameters	25
	Using the 3336A, B or C as a Sweeper	25
	Using the Storage Registers	26
	Operating the Phase Control	26
	Rear Panel Outputs	26
	Options	27
	Applications	27
	Wideband Sweep	27
	Swept Measurements Using the 3575A Gain/Phase Meter	29
	Phase, Dual Phase and Synchronizing	29
	Linearity Testing of VCO's	30
	Phase Lock Loop Testing	31

Chapter V Remote Operation	32
Introduction	32
HP-IB Extender	32
Remote Operation of the 3586A, B & C SLM	32
Instrument Programming Codes	32
Formats for Programming	32
Outputting Data	35
Measure Instructions	35
Interrogate	35
Other Considerations	35
Require Service	35
Typical HPL Program	36
3336A, B & C S/LG Remote Operation	37
Control Modes	37
Learn Mode	37
Programming with the 9825A Calculator	37
HP-IB Programming Codes	39
Parameter Interrogation	40
Status Byte	40
Abridged Description of the HP-IB	41
Chapter VI Technical Description	42
3586A, B & C SLM	42
3336A, B & C S/LG	43
Chapter VII Serviceability	45

This User's Guide for the HP 3586A, B and C Selective Level Meter and the HP 3336A, B and C Synthesizer/Level Generator shows how these new instruments can be utilized as solutions for your wave analysis, FDM system and frequency synthesis applications.

For quick review of operating features, turn to page 4. HP-IB remote operation information is provided on page 32.

For more information, contact your local Hewlett-Packard Field Sales Office.

Chapter I

Introduction

The 3586A, B and C Selective Level Meter and the 3336A, B and C Synthesizer/Level Generator represent a powerful combination of precision microprocessor-based instruments for general purpose wave analysis, frequency synthesis and FDM system measurements.

Three Models to Fit Your Needs

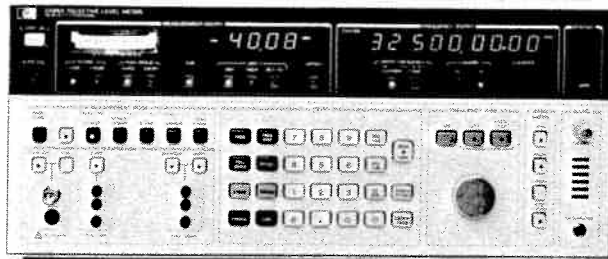

3586A Selective Level Meter

Meets CCITT
Requirements



3336A Synthesizer/Level Generator

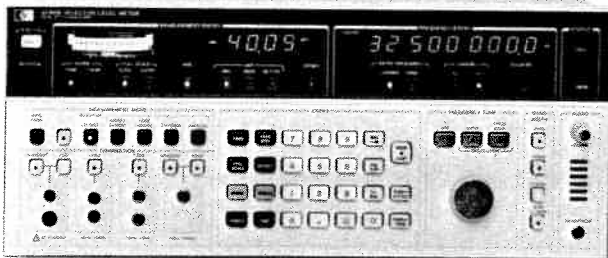

3586B Selective Level Meter

Meets North American
(Bell) Requirements

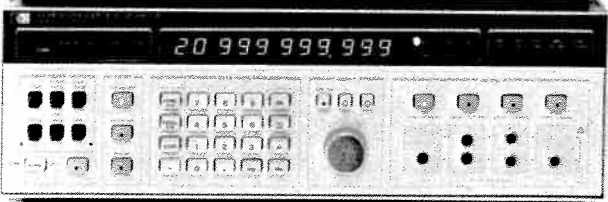

3336B Synthesizer/Level Generator

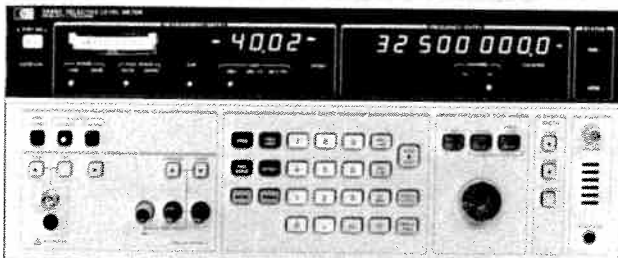

3586C Selective Level Meter

For General Purpose
Wave Analysis and
Frequency Synthesis

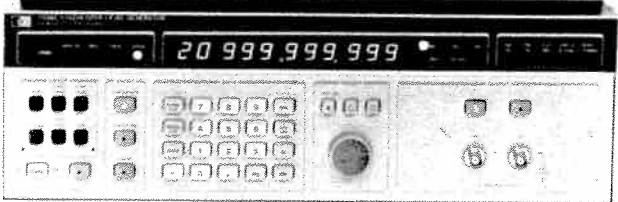

3336C Synthesizer/Level Generator

3586A, B & C Selective Level Meter

50 Hz to 32.5 MHz

The HP Model 3586A, B and C Selective Level Meters are designed for use in general purpose and Telecommunication applications including audio, sonar, HF radio and Frequency Division Multiplex (FDM) systems testing.

The wide frequency coverage of 50 Hz to 32.5 MHz, combined with excellent measurement accuracy and precision makes this powerful microprocessor based instrument your best choice for design, manufacturing and maintenance operations requiring highly accurate selective wave analysis or FDM voice grade and carrier level measurements.

Accuracy, Precision, Selectivity

HP Models 3586A, B and C combine up to $\pm .2$ dB level accuracy with a unique fractional-N frequency synthesis technique to allow highly selective level measurements with 0.1 Hz frequency resolution and .01 dB amplitude resolution and full auto-ranging and automatic calibration.

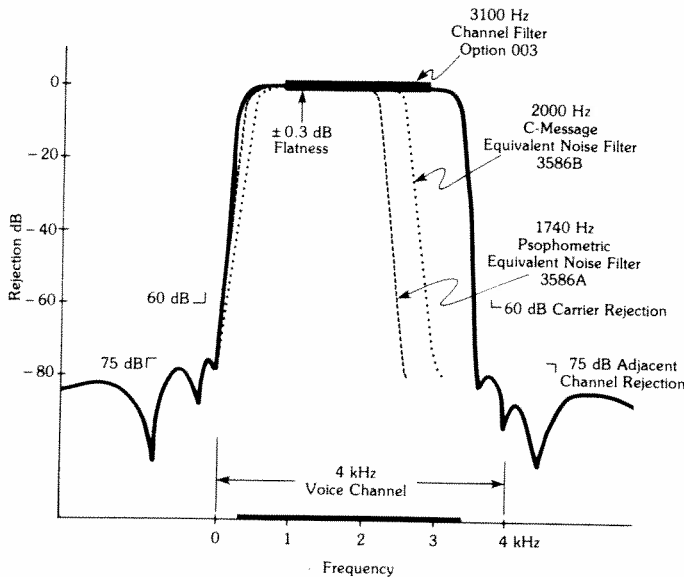

Filters from 20 Hz to 3100 Hz bandwidth are available with shape factors to 1.2, performance available first from Hewlett-Packard. You can resolve signals as close as 80 Hz apart with 50 dB rejection, or use the 3100 Hz filter as a "tunable channel bank filter," virtually duplicating the performance characteristics of channel filters in an FDM system.



Use the accurate frequency counter to measure the frequency of a signal, and then tune to it with synthesizer precision in one keystroke.



The amplitude offset feature allows you to make amplitude level measurements with respect to any reference level to speed harmonic or tone level measurements. A measured level can be made a reference level at a keystroke.

The Wideband Power measurement mode lets you make true RMS baseband power measurements down to -45 dBm with up to ± 1 dB accuracy.

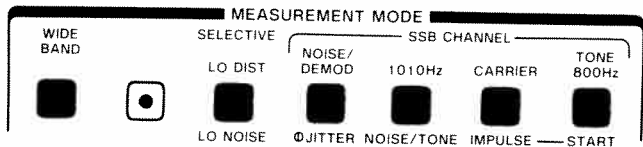

Fast SSB Testing

The Single Side Band (SSB) measurement mode provides demodulation capability with speaker or headphone output. The demodulated audio can be output for further processing or measurement. 3586A and B models allow the user to enter a FDM carrier or tone frequency, choose an inverted (∇) or erect (\sphericalangle) sideband and precisely align the 3100 Hz channel filter on a voice channel. Choose from a "menu" of measurements including channel noise, power or demodulation, carrier leak or tone level measurement (plus signalling tone level in the Model 3586B).

Transmission Impairments Option

Transmission Impairment measurements including noise-with-tone, signal to noise-with-tone ratio, phase jitter, and single level impulse noise, and a C-message or Psophometric noise filter can be added to A or B model instruments with Option 003. Use this capability to compare voice channel impairments at both voice grade and carrier level for FDM troubleshooting.

Worldwide Connectors and Impedances

The modular front-end design allows a selection of impedances and connectors for general purpose, CCITT or North American (Bell) requirements. Choose impedances and connectors by model or option. Most special connector requirements can be met, contact your local HP field sales office to discuss your specific needs.

Model	Input Impedance	Mating Connector
3586A	75 Ω /10k Ω Unbalanced	BNC (1.6/5.6 mm metric)*
CCITT	150 Ω , 600 Ω /10k Ω Balanced	Siemens 3 prong 9REL-6AC
3586B	75 Ω /10k Ω Unbalanced	WECO 439A/440A (358A)*
No. American (Bell)	124 Ω Balanced	WECO 443A (372A)*
	135 Ω Balanced	WECO 241A
	600 Ω /10k Ω Balanced	WECO 310
3586C	50 Ω /75 Ω /10k Ω Unbalanced	BNC
General Purpose	600 Ω /10k Ω Balanced	Dual Banana .75" spacing

*Optional

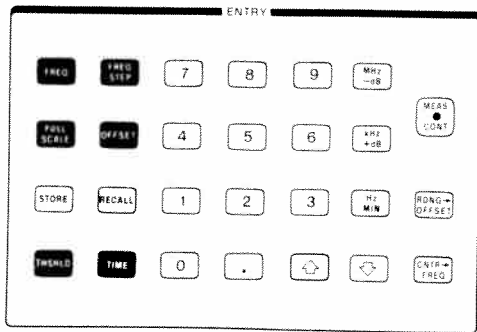

Many Convenience Features

Microprocessor power and flexibility provides additional ease-of-use features including frequency stepping, amplitude units in dBm, dBV or dBpW, analog frequency control with variable resolution, and low distortion or low noise operating modes. Nine storage registers allow multiple front panel setting configurations to be stored for later use. This feature significantly speeds repetitive manufacturing testing.



Programmable

All necessary functions on the 3586A, B and C Selective Level Meter are HP-IB programmable by HP 9800 series Desktop Computer controllers, or by a mainframe computer like the HP 1000. Fast, efficient manufacturing testing maintenance and calibration, and automatic, remote FDM system surveillance are only a few applications. The HP-IB is also used for implementing frequency tracking with the 3336A, B and C and 3335A Synthesizer/Level Generators.

3336A, B and C Synthesizer/Level Generator

10 Hz to 20.9 MHz

The HP Model 3336A, B and C Synthesizer/Level Generators are designed for General Purpose, Telecommunications and FDM system applications requiring a high accuracy, high resolution stable signal source with precise output level, excellent spectral purity and wideband sweep capability. The 3336A, B and C can also be used as a frequency tracking companion synthesizer for the 3586A, B and C Selective Level Meter up to 20.9 MHz for frequency response and FDM system testing.



Frequency Precision and Spectral Purity

The HP 3336A, B and C provide one microhertz (.000001 Hz) resolution up to 100 kHz and one millihertz (.001 Hz) up to 20.9 MHz with frequency accuracy and stability of $\pm 5 \times 10^{-6}$, ($\pm 5 \times 10^{-8}$ stability optional). Harmonics are down 60 dB to 1 MHz and down 50 dB to 20.9 MHz, performance not previously available in a synthesizer.

$\pm .05$ dB Accuracy

The 3336A, B and C combine outstanding frequency accuracy and purity with absolute amplitude accuracy of $\pm .05$ dB at 10 kHz or 50 kHz and $\pm .1$ dB flatness (.07 dB optional) at full output. Overall 75 ohm accuracy is $\pm .22$ dB with the optional high accuracy attenuator over the full frequency range, down to -72.99 dBm output.

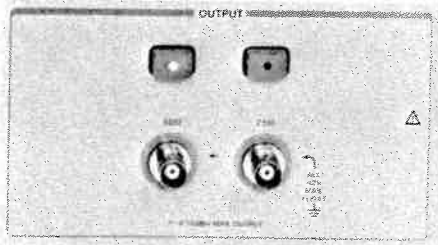
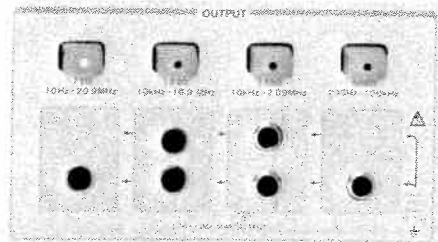
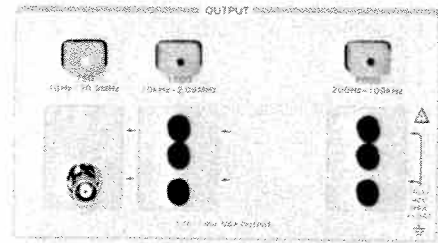

Worldwide Impedance/Connector Options

Like the 3586A, B and C Selective Level Meter, impedance and connector combinations are available for CCITT, North American (Bell) and general purpose applications.

Model	Output Impedance	Output Connector
3336A CCITT	75Ω Unbalanced 150Ω Balanced 600Ω Balanced	BNC (1.6/5.6 mm metric)* Siemens 3-prong 9 REL-6 AC
3336B No. American (Bell)	75Ω Unbalanced 124Ω Balanced 135Ω Balanced 600Ω Balanced	WECO 439/440A (358A)* WECO 443A (372A)* WECO 241A WECO 310
3336C General Purpose	50Ω Unbalanced 75Ω Unbalanced	BNC

* Optional

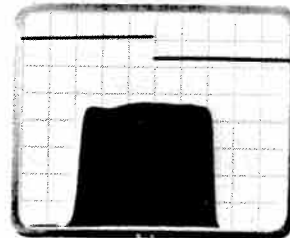

Precision Broadband Sweep

HP Models 3336A, B and C provide unique leveled sweep capabilities including full band phase continuous sweep, single or continuous, log or linear with $\pm .15$ dB flatness at full output. X, Y and Z axis outputs allow oscilloscope or X-Y recorder display of swept frequency response with a precise TTL output frequency marker.

Chapter II

Front Panel Features

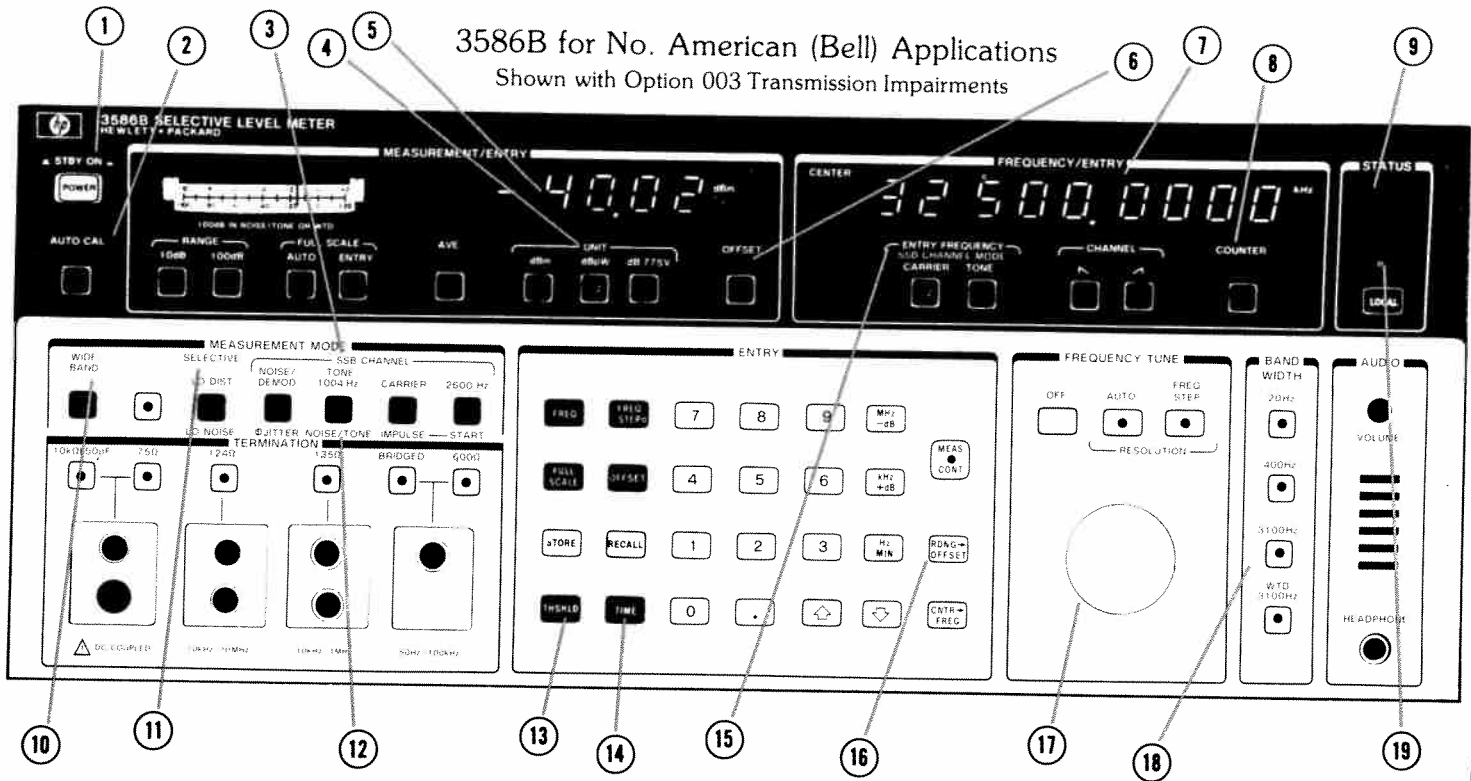

3586A for C.C.I.T.T. Applications (same as 3586B except as shown)

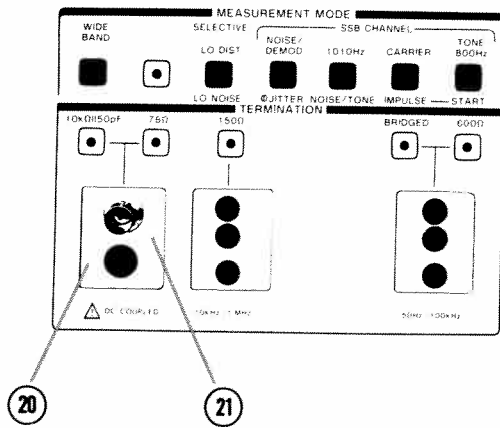

3586A, B Selective Level Meters

- ① POWER STANDBY applies power to High Stability Reference oven, Option 004, HP-IB interface and power supplies.
- ② AUTOMATIC LEVEL CALIBRATION occurs approximately every three minutes or when the frequency change is > 1 MHz.

- ③ SSB CHANNEL measurements include a "menu" of tests available at a keystroke. Enter this mode by choosing the FDM carrier or test tone frequency as an entry frequency, LSB (N) or USB (A) and any one of four measurements.
NOISE/DEMOD. (3586A/B only), is used for idle channel noise, noise power or channel demodulation. The 1740 Hz (3586A), 2000 Hz (3586B), or 3100 Hz (Option 003) bandpass filter is automatically chosen and aligned on the voice channel.
1010 Hz and 800 Hz ± 15 Hz TONE levels or CARRIER leaks are measured at a keystroke on the 3586A after the SSB CHANNEL mode is entered. 1004 Hz TONE or 2600 Hz SIGNALing tone or CARRIER leak measurements are available on the 3586B. The 20 Hz bandwidth is chosen automatically.

- ④ CHOOSE UNITS for level, noise in db picowatts, (3586A/B only), or dBV referenced to .775V, (0 dBm into 600Ω).
- ⑤ AMPLITUDE DISPLAY provides .01 dB resolution in 10 dB range and .1 dB in 100 dB range mode. Measurement range is +20 to -120 dBm. Level, FULL SCALE level, OFFSET level and OPTION 003 impulse noise threshold level can be displayed.
- ⑥ OFFSET allows amplitude measurements relative to a keyboard entered or measured level.

7

FREQUENCY DISPLAY is 9 digits with .1 Hz resolution. Displays all frequencies entered or counted or Option 003 Impulse Noise time period in minutes and seconds.

8

COUNTER is used to measure any signal frequency within the 60 dB points of the IF bandpass (or -100 dBm) to an accuracy of ± 1.0 Hz plus the center frequency accuracy. Use with to tune to the measured frequency without "rocking."

9

HP-IB STATUS lights indicate bus mode.

10

WIDEBAND measurements such as baseband power are made from 200 Hz to 32.5 MHz over +20 to -45 dBm with an RMS detector. In this mode the front end is "wide open" with no pre-selection filtering. The RMS value of all signal and noise power in the frequency is measured and displayed.

11

SELECTIVE measurements mode is used for basic wave analysis measurements with the precise center of the bandpass at the entered and displayed frequency. LO DIST (Low Distortion) is used for most selective measurements such as harmonic and intermodulation and spurious levels. In the LO NOISE (Low Noise) mode, the noise floor is reduced for better accuracy for noise and low level signals close to the noise.

12

OPTION 003 instruments add these three impairment measurements to the SSB CHANNEL menu. (3586A/B only)

13

Set threshold level for impulse noise measurements (Option 003 only) from -45 dBm to -120 dBm in 1 dB steps.

14

Set time period for impulse noise measurements (Option 003 only) up to 99 minutes and 59 seconds. A 0 Time Entry sets up a continuous measurement.

15

ENTRY FREQUENCY can be an FDM test tone or carrier frequency used to automatically align the channel filter on a voice channel in the SSB CHANNEL measurement mode. In this mode the center of the passband is not the frequency displayed unless the tone or carrier level is being measured. (See SSB Channel Measurement Mode).

16

Use RDNG-OFFSET to make a measured level an offset. Subsequent measurements will be made relative to that level when offset is on.

17

MANUAL TUNING RESOLUTION is chosen by the operator in the FREQUENCY STEP MODE in .1 Hz to 32.5 MHz steps. Resolution is .2, 4 or 20 Hz in AUTO.

18

3100 Hz and 3100 Hz WTD FILTERS are part of OPTION 003 on the 3586A/B. Standard filters are 1740 Hz (Psophometric equivalent on the 3586A), and 2000 Hz (C-message equivalent on the 3586B).

19

FREQUENCY TRACKING with the 3586A, B Synthesizer/Level Generator is enabled by changing the bus switch to Remote and connecting HP-IB interfaces. The frequency of the synthesizer will always be the same as the SLM in this mode.

20

Probe Power is compatible with HP High Impedance Accessory Probes.

21

The 3586A & B are designed with a flexible output section to allow special connectors to be provided at minimum cost.

3586C for General Purpose Applications

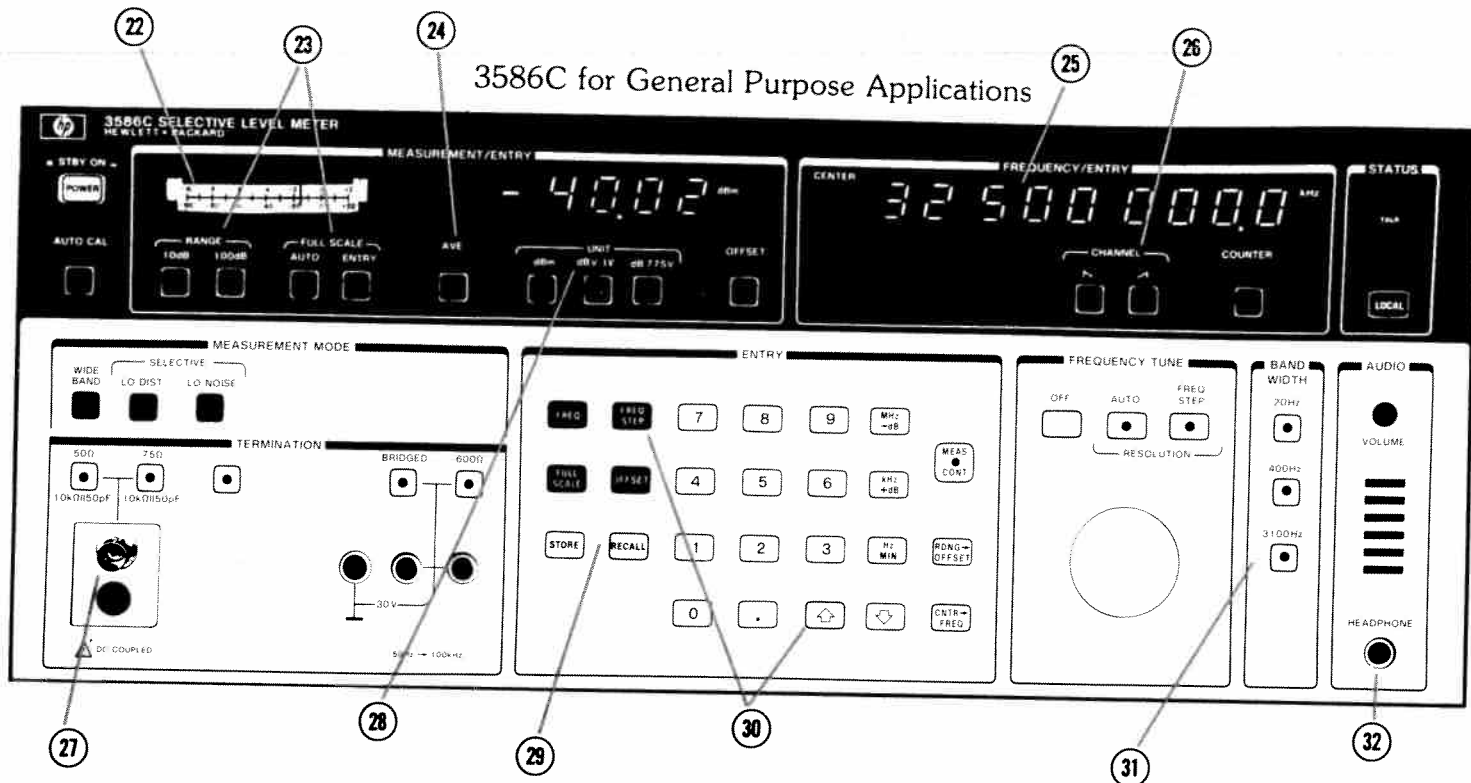

3586C Selective Level Meter

- 22** ANALOG METER for "peaking" signals in the FULL SCALE ENTRY mode.
- 23** 10 dB RANGE and FULL SCALE AUTO automatically chooses the proper range and full scale level for best signal to noise ratio and measurement accuracy and .1 dB resolution.
- 24** AVERAGING averages five measurements and displays the result once a second to minimize "racking" during noise measurements.
- 25** SSB measurement are made on the 3586C in the selective mode by manually offsetting the frequency from the carrier frequency.
- 26** CHANNEL chooses LSB (N) or USB (A) for SSB operation.
- 27** 50Ω for general purpose RF measurements.
- 28** Measure in units of dB, dBV referenced to 1V, or dB referenced to .775V on the 3586C.
- 29** Nine non-volatile storage registers can be used to store nine front panel settings for repetitive measurements. RECALL ZERO sets the front panel to the turn-on condition.
- 30** Enter a frequency step from .1 Hz to 32.5 MHz and then use these keys or the frequency tune control to step the frequency. The **FREQ STEP** keys can be used to step the full scale setting in 5 dB steps, or the impulse noise threshold, (option 003 only) in 1 dB steps.
- 31** 3100 Hz BW (flat) is standard on the 3586C.
- 32** HEADPHONE OUTPUT provides 0 dBm into 600Ω. Also can be used for further measurements on demodulated AUDIO.

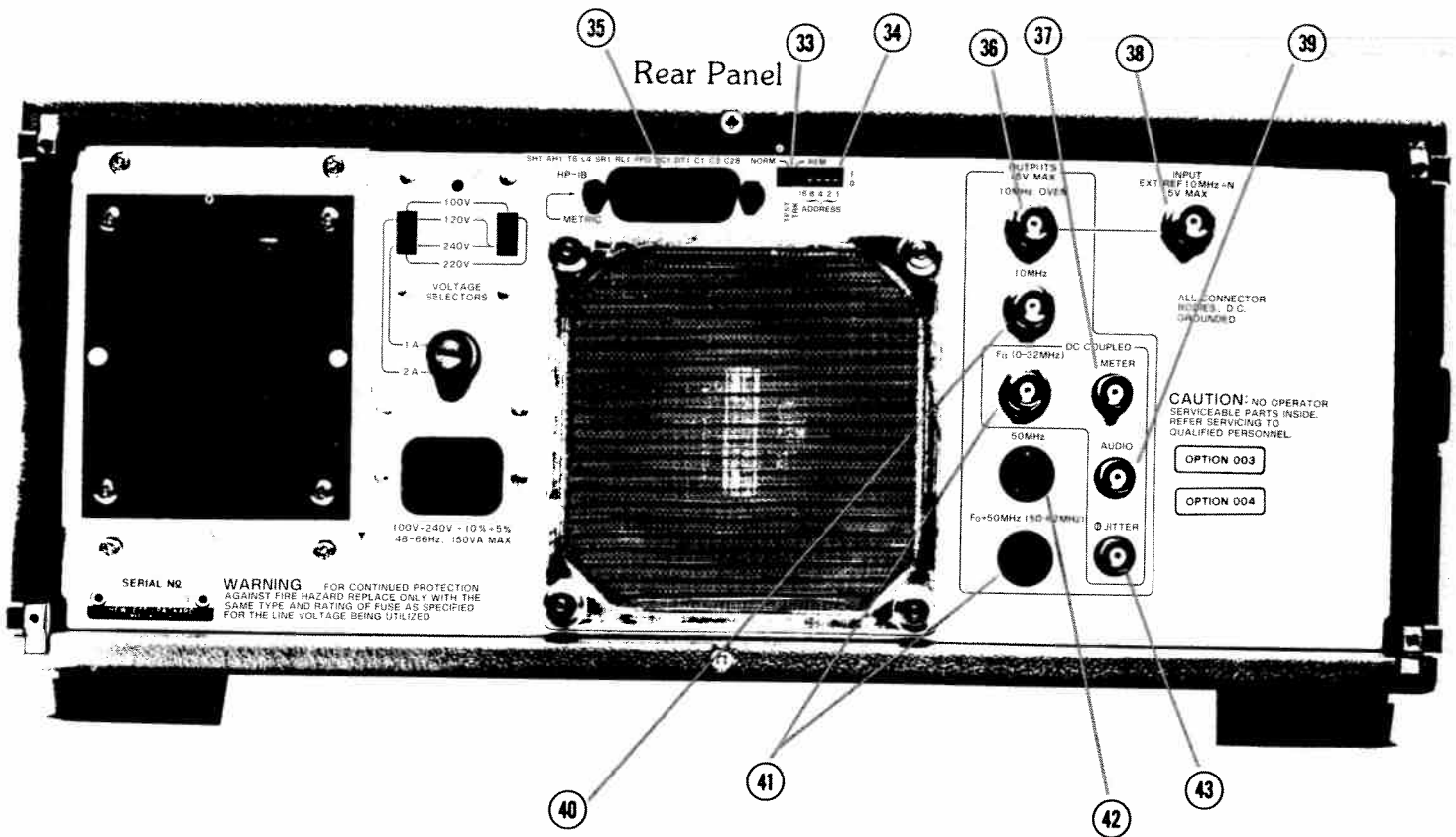

3586A/B/C Rear Panel

- 33** TRACKING SYNTHESIZER SWITCH, set to TRK for talk only mode for frequency tracking. Set to REM (Remote) for normal HP-IB operation.
- 34** HP-IB ADDRESS SWITCHES, Binary weighted switches to set TALK/LISTEN address.
- 35** HB-IB INTERFACE accepts all metric thread HP 10631 cables. For HP-IB or frequency tracking with 3336A/B/C or 3335A Synthesizer.
- 36** 10 MHz OVEN REFERENCE OUTPUT, (Option 004 only), $\pm 1 \times 10^{-7}$ stability, connected to 10 MHz + N by jumper.
- 37** Meter output provides 10 mV/dB on 100 dB range and 100 mV/dB on 10 dB range. Output is offset so 0 dB is 0 mV out.
- 38** 10 MHz + N input is used to lock the 3586A, B or C to a 1 MHz to 10 MHz 0 to +20 dBm reference (must be a sub-harmonic of 10 MHz, 1, 2.5, 3.33 MHz, etc.).
- 39** Audio output provides the demodulated audio, .75 V_{rms} into 1 k Ω at full scale level.
- 40** 10 MHz REFERENCE OUTPUT, $\pm 1 \times 10^{-5}$ stability.
- 41** TRACKING OUTPUT provides an output signal at the band-pass center frequency for frequency response measurements. Level is 0 dBm \pm .5 dB (at 10 kHz) with \pm .5 dB flatness.
- 42** 50 MHz auxiliary and F₀ + 50MHz outputs are not connected to REAR PANEL.
- 43** PHASE JITTER OUTPUT provides 20 to 300 Hz demodulated-Phase Jitter Spectrum, sensitivity is 166 mV/o. (3586A/B Option 003 only).

3336A for C.C.I.T.T. Applications

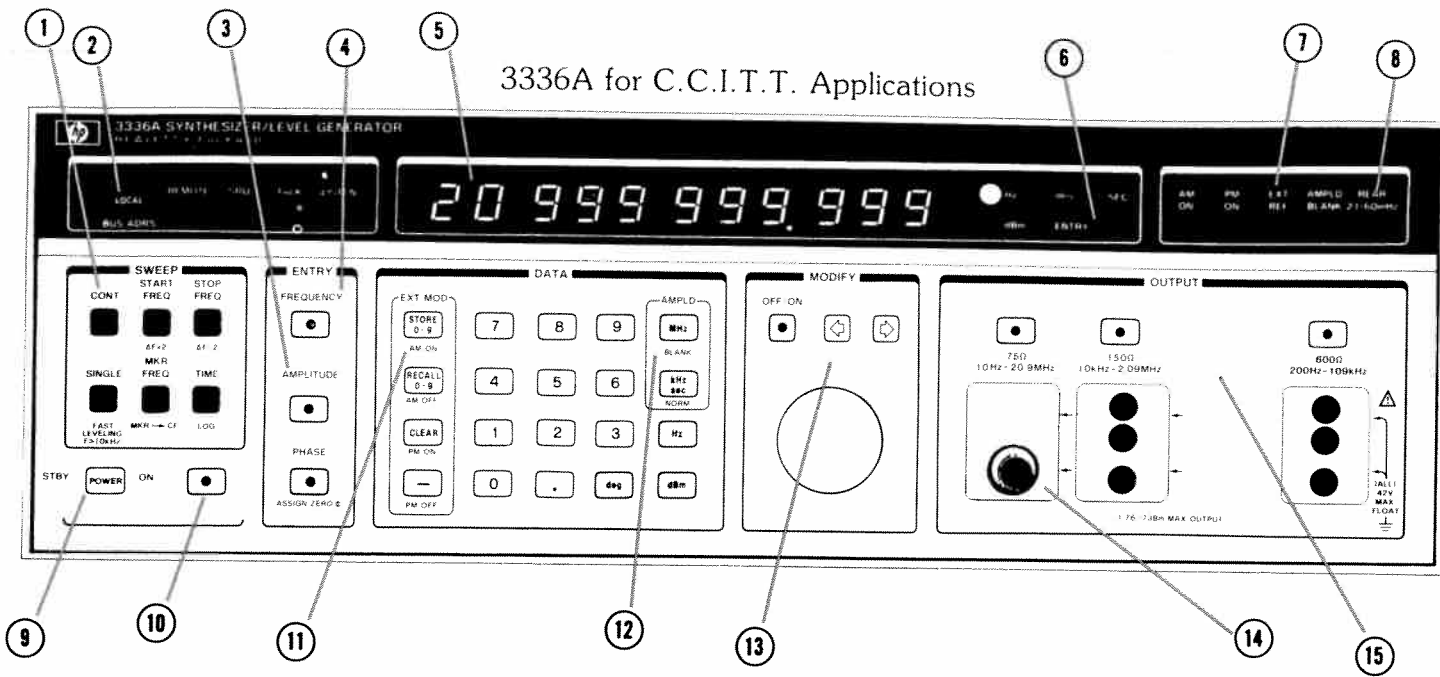

3336B for North American (Bell) Applications (same as 3336A except as shown)

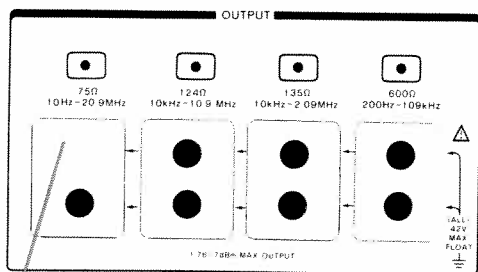

3336C for General Purpose Applications (same as 3336A except as shown)

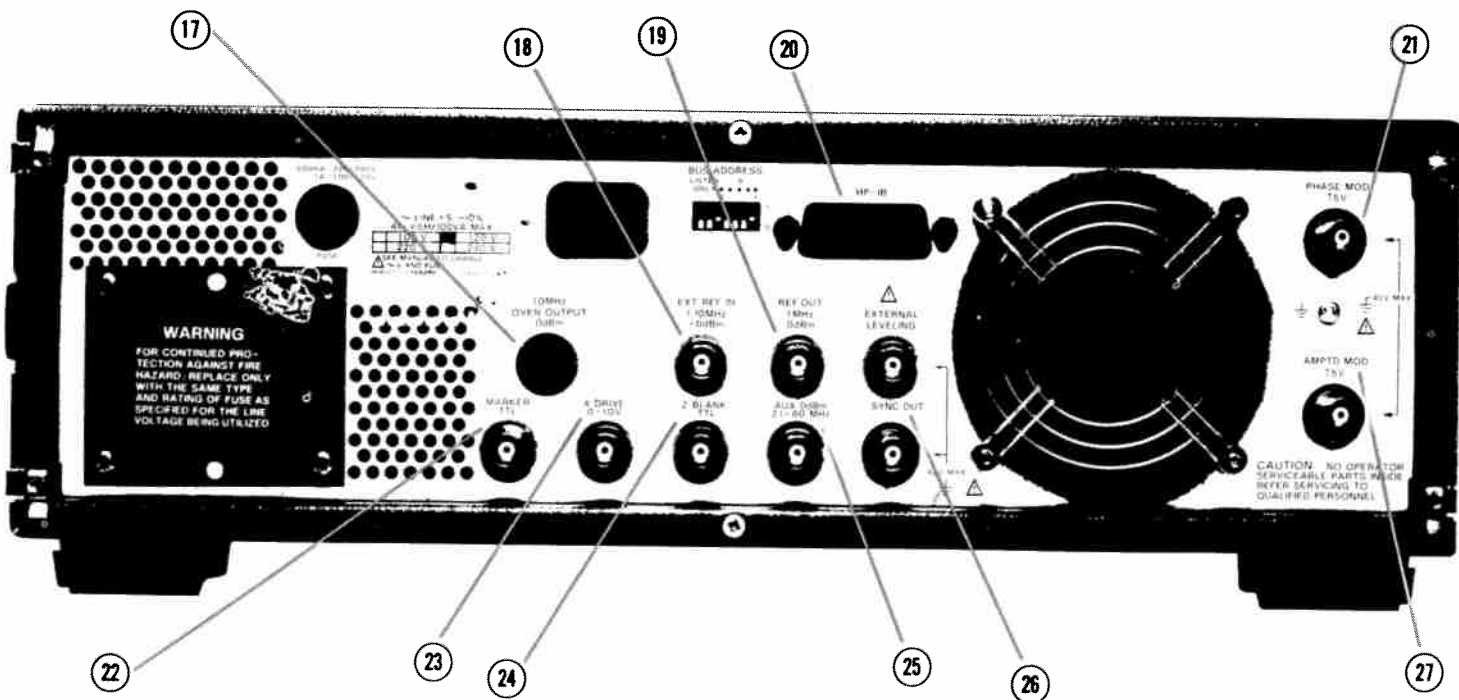
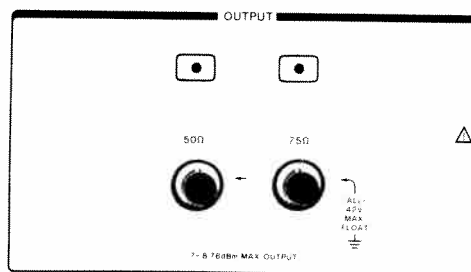

3336A, B & C Synthesizer/Level Generator

- 1 Sweep entry, sweep start, and sweep modification keys. BLUE PREFIX keystroke required to initiate sweep modification, log sweep, or to choose fast or slow leveling.
- 2 HP-IB STATUS lights indicate bus mode.

LOCAL keystroke returns 3336A,B,C from remote to front panel unless local lockout is programmed.

LOCAL keystroke preceded by BLUE PREFIX keystroke initiates bus address in display.
- 3 OPTION 005 HIGH ACCURACY ATTENUATOR improves amplitude accuracy at > 9.99 dB attenuation from full output.
- 4 SIGNAL PARAMETER PREFIX KEYS. PHASE keystroke when preceded by BLUE PREFIX keystroke will assign zero phase (ASGN ZERO 0) to any previously selected phase offset.
- 5 PARAMETER DISPLAY (11 digits max.) of Frequency Amplitude.
- 6 Entry light is "on" when 3336A is waiting for DATA following an ENTRY selection. Data and units of frequency, amplitude, phase, or sweep time must be selected to complete the entry.

UNIT light is "on" when entry is complete. Output signal assumes new entered value.
- 7 EXT REF light is "on" when external frequency reference or Option 004 10 MHz high stability reference is connected to the rear panel REF IN. This light flashes if phase lock not complete.

MODULATION lights "on" when AM or PM is selected.
- 8 LIGHT "ON" when a frequency of 21 MHz or greater is selected. Output is automatically switched to rear panel aux. output. See rear panel view.
- 9 POWER STANDBY applies power to High Stability Reference Oven Option 004, HP-IB interface circuits, and power supplies.
- 10 BLUE PREFIX key used for double coding several keys.
- 11 STORE/RECALL up to 10 full front panel settings.

AM enabled (ON) when BLUE PREFIX keystroke followed by STORE; disabled (OFF) by BLUE PREFIX/RECALL.

PM enabled (ON) by BLUE PREFIX/CLEAR; disabled (OFF) by BLUE PREFIX/-. Modulation inputs on rear panel.
- 12 "SOFT" AMPLITUDE BLANKING to < -85 dBm enabled by BLUE PREFIX key followed by MHz/BLANK; disabled by kHz/NORM.
- 13 selects the parameter digits to be modified, then use the analog control to tune frequency, amplitude, phase offset or sweep parameters.
- 14 3336A OPTION 001 provides 75 Ω 1.6/5.6mm coaxial connector.
- 15 OUTPUT IMPEDANCES and connectors meet C.C.I.T.T. NORTH AMERICAN (BELL), or GENERAL PURPOSE requirements.
- 16 OPTION 001 provides large WECO on 75 Ω and 124 Ω .
- 17 HIGH STABILITY REFERENCE OPTION 004 provides 5×10^{-8} per week stability. Output must be jumpered to EXT REF IN.
- 18 EXTERNAL REFERENCE INPUT phase locks to external stable reference signal or Option 004 output.
- 19 1 MHz REFERENCE OUTPUT to phase lock other instruments to 3336A,B,C.
- 20 HP-IB CONNECTOR.
- 21 PHASE MODULATION INPUT 5 kHz maximum (can work simultaneously with AM).
- 22 MARKER OUTPUT, a TTL (0 to 5V) negative going transition during sweep.
- 23 X-AXIS DRIVE provides 0 to 10V sweep drive for oscilloscope or plotter displays.
- 24 Z-AXIS OUTPUT blanks retrace on swept display.
- 25 21 to 60.9 MHz AUXILIARY OUTPUT provides 0 dBm signal when frequency keyed in on front panel is ≥ 21 MHz. Output will under-range to 20 MHz. To return to main signal output, < 20 MHz must be keyed in.
- 26 SYNC OUTPUT TTL SQUAREWAVE OUTPUT; frequency identical to main output, zero crossing lags main output by 25 ns (nominal).
- 27 AMPLITUDE MODULATION INPUT 10 Hz to 50 kHz.

Chapter III

Specification Summary

3586A, B & C Selective Level Meter

Frequency

Range: 50 Hz to 32.5 MHz
 Accuracy: $\pm 1 \times 10^{-5}/\text{Yr.}$ ($\pm 2 \times 10^{-7}/\text{Yr.}$ optional)
 Resolution: .1 Hz
 Counter Accuracy: $\pm 1.0 \text{ Hz} + .1 \text{ Hz}$

Signal Inputs	3586A	3586B	3586C
75Ω 10kΩ	50 Hz to 32.5 MHz		
50Ω		50 Hz to 32.5 MHz	
124Ω		10 kHz to 10 MHz	
135Ω		10 kHz to 1 MHz	
150Ω	10 kHz to 1 MHz		
600Ω 10kΩ	50 Hz to 100 kHz		

Selectivity 3 dB Bandwidth $\pm 10\%$

3586A	3586B	3586C
20 Hz	20 Hz	20 Hz
400 Hz	400 Hz	400 Hz
1740 Hz*	2000 Hz*	3100 Hz

*3100 Hz and WTD optional

Adjacent Channel Rejection: 75 dB
 Carrier Rejection: 60 dB
 Passband Flatness: $\pm .3 \text{ dB}$

Amplitude

Range: +20 to -120 dBm
 Resolution: .01 dB
 Level Accuracy: +20 to -80 dBm

75 50Ω	$\pm 2 \text{ dB}$	20 kHz to 18 MHz
124Ω	$\pm 35 \text{ dB}$	50 kHz to 5 MHz
135Ω 150Ω	$\pm 35 \text{ dB}$	50 kHz to 1 MHz
600Ω	$\pm 35 \text{ dB}$	200 kHz to 100 kHz
Wideband Power 75Ω	$\pm 1 \text{ dB}$	20 kHz to 10 MHz, +20 to -45 dBm

Noise Floor (Full Scale Setting -35 to -120 dBm)

Frequency	Bandwidth	Noise Level
	3100, 1740, 2000 Hz	-116 dBm
100 kHz to 32.5 MHz	20,400 Hz	-120 dBm
100 kHz to 100 kHz	All	-105 dBm

Dynamic Range

Image Rejection (100-132 MHz): -80 dBc
 IF Rejection: 15625 Hz, -80 dBc
 50 MHz -60 dBc
 Spurious Signals: > 1600 Hz offset, -80 dBc
 300 Hz to 1600 Hz offset, -75 dBc
 Distortion:
 Harmonics: -70 dB below full scale, Lo distortion mode
 IM: -70 dB below full scale, 200 Hz to 20 kHz offset
 -75 dB below full scale, 20 kHz to 1 MHz offset

HP-IB Control Standard

Options	3586A	3586B	3586C
001 Connectors	75Ω 1 6/5 6 mm replaces BNC	75Ω WECC 124Ω WECC replaces mini WECC	
002 Bandwidth	—	1740 Hz replaces 2000 Hz	—
003 Transmission Impairments	Adds Phase jitter 3100 Hz, WTD, Noise with-tone, Single Level Impulse Noise		
004 High Stability Frequency Ref Oscillator	$\pm 2 \times 10^{-7}/\text{yr}$	Stability	

3336A, B & C Synthesizer/Level Generator

Frequency

Range: 10 Hz to 20.9 MHz
 Accuracy: $\pm 5 \times 10^{-6}$ ($\pm 5 \times 10^{-8}$ optional)
 Resolution: 1 μHz , < 100 kHz; 1 mHz \geq 100 kHz

Signal Outputs

Output	3336A	3336B	3336C
50Ω			10Hz to 20.9MHz
75Ω	10Hz to 20.9MHz		
124Ω	10kHz to 10.9MHz		
135Ω	10kHz to 2.09MHz		
150Ω	10kHz to 2.09MHz		
600Ω	200Hz to 109.9kHz		

Amplitude

Range:
 50Ω: -71.23 to +8.76 dBm
 75Ω, 600Ω: -72.99 to +1.00 dBm
 124Ω, 135Ω, 150Ω: -78.23 to +1.76 dBm
 Resolution: .01 dB
 Accuracy: $\pm .05 \text{ dB}$, 20°C to 30°C, at 10 kHz for 50, 75, 600Ω outputs or 50 kHz for 124, 135, 150Ω outputs ($\pm .08 \text{ dB } 0^\circ$ to 55°).
 Flatness: $\pm .1 \text{ dB}$ ($\pm .07$ Option 005), at full output
 Attenuator Accuracy: $\pm .1$ to $\pm .3 \text{ dB}$ Standard
 $\pm .035$ to $\pm .1 \text{ dB}$ Option 005
 Blanking: soft blanking to $< -85 \text{ dBm}$

Spectral Purity

Harmonic Levels: -60 dB 50 Hz to 1 MHz
 -55 dB 1 MHz to 5 MHz
 -50 dB 5 MHz to 20.9 MHz
 Phase Noise: Integrated, -60 dB/30 kHz BW
 SSB, -70 dB, 3 kHz BW, $F_c \pm 2 \text{ kHz}$
 Spurious: 70 dB down or -100 dBm (-115 dBm with Option 005, depends on output and frequency)
 Phase jitter: $< \pm 0.3^\circ \text{ p-p}$

Modulation

AM: 50 Hz to 50 kHz, 0 to 100%
 PM: DC to 5 kHz, 0 to $\pm 850^\circ$

Phase Offset

$\pm 719.9^\circ$ vs. arbitrary starting phase or 0° relative

Frequency Sweep

Sweep Range: Full range of signal output
 Sweep Time: .01 s to 99.9 s, depends on mode
 Flatness: $\pm .15 \text{ dB}$, fast level, .03 s

HP-IB Control Standard

Options	3336A	3336B	3336C
001 Connectors	75Ω 1 6/5 6 mm replaces BNC	75Ω/124 Large WECC	
004 High Stability Frequency Reference	$\pm 5 \times 10^{-8}$ Accuracy		
005 High Accuracy Attenuator	Improved Attenuator Accuracy		

Chapter IV

Operation & Applications

3586A, B & C Selective Level Meter

Basic Measurement Modes

The 3586A, B or C can make SELECTIVE, SSB CHANNEL, or WIDEBAND power measurements for a wide variety of general purpose wave analysis and FDM system measurements. This section describes how basic measurements are easily made in each mode.

Selective Measurements

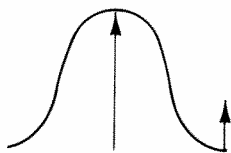

Getting Started

Selective is the normal "wave analyzer" mode for selective measurement of discrete frequencies, spurious, harmonics, pilot tones, carrier leaks or noise levels. In this mode the entered and displayed frequency is the precise center of the passband.

- At turn-on, the 3586A, B or C is ready for selective measurements. The basic configuration is SELECTIVE, LO DIST, 10 dB RANGE, FULL SCALE AUTO.
- Choose the proper input impedance for your application.
- Enter your frequency by pressing **FREQ**, your numerical frequency digits, and complete the entry by pressing **Hz**, **MHz**, or **KHz** as appropriate to your entry. If your frequency is within the 3100 Hz bandwidth, the level will be displayed with .01 dB resolution.

To make more selective measurements, choose the 400 Hz or 20 Hz bandwidth. If the signal falls outside the bandwidth chosen, enable the FREQUENCY TUNE control by pressing **AUTO** and tune to the signal.

Automatic Fine Tuning with the Counter

The 3586 can be automatically tuned so that the passband is centered precisely on the strongest signal in the passband by turning on **FREQ** to measure the actual frequency, followed by **CNT** **FREQ** which tunes the passband center to the counted frequency. The counter accuracy is $1.0 \text{ Hz} \pm .1 \text{ Hz}$, in addition to the center frequency accuracy of the instrument. The counter will measure the strongest level within the 60 dB points of the filter, down to -100 dBm . If two or more signals are within 3 dB of each other or less, a measurement uncertainty results.

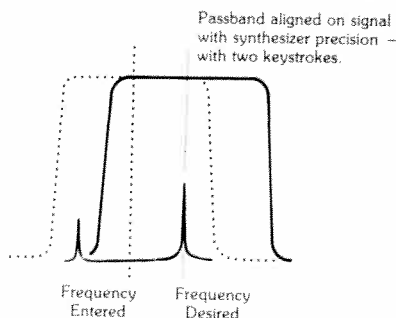

Low Distortion vs. Low Noise

In the SELECTIVE mode, the operator has the choice of LO DIST (low distortion) or LO NOISE (low noise) operation. Low distortion is used for most selective level measurements. In this mode, RF and IF gain levels are chosen for most linear operation, providing best harmonic and intermodulation performance. When in doubt, use LO DIST. The LO NOISE selective mode adjusts RF and IF gains to reduce the noise floor by about 5 dB to provide better accuracy for noise level measurements, and small signal measurements close to the noise. Enter this mode by pressing the BLUE PREFIX key, **LO NOISE**.

SSB Channel Measurements (3586A or B)

The Single Sideband (SSB) channel measurement mode is used to make level and noise measurements on a telecommunications voice channel such as in a Frequency Division Multiplex (FDM) system, or for SSB AM demodulation to listen to audio or to use the demodulated audio for further measurements using additional instrumentation.

The SSB Voice Channel

A SSB voice channel is offset from a carrier on either the upper (USB) or lower (LSB). The carrier and unwanted sideband are suppressed at the transmitting end by phasing or filtering techniques.

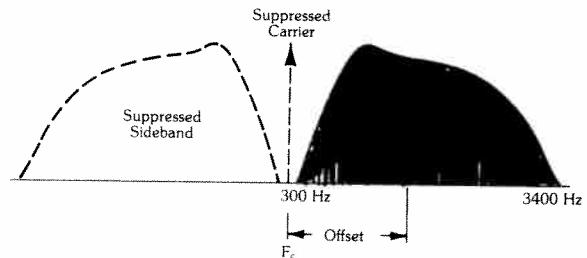

An Upper Sideband SSB Channel

In telecommunications nomenclature:

LSB = "INVERTED CHANNEL" = \searrow
 USB = "ERECT CHANNEL" = \swarrow

The audio sideband bandwidth is usually restricted to 300 to 3400 Hz away from the carrier, so to make measurements on this channel we must place the SLM bandpass filter precisely over the channel. The power of the microprocessor allows us to do this automatically, with synthesizer precision on the 3586A or B. We can enter the SSB channel mode using the known carrier (or test tone) frequency, choose USB or LSB operation and then choose from a "menu" of SSB channel measurements.

The required frequency offsets are automatically computed and the bandpass tuned to the proper frequency depending on the measurement chosen.

3586A/B SSB Measurement "Menu"

The table shows the SSB channel measurements available on standard 3586A & B and Option 003 instruments. The offsets shown are for carrier frequency reference entry.

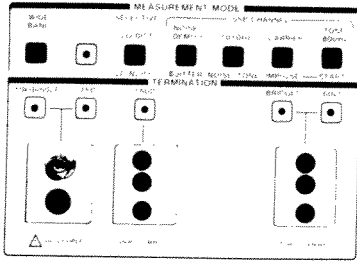

SSB Channel Measurement	3586A (Standard)		3586A (Option 003)	
	Offset From Carrier*	Bandwidth	Offset From Carrier*	Bandwidth
Noise/Demod (Noise or demodulated audio)	± 1350 Hz	1740 Hz	± 1850 Hz	3100 Hz
1010 Hz ± 15 Hz	± 1010 Hz	20 Hz	± 1010 Hz	20 Hz
Carrier	0	20 Hz	0	20 Hz
Tone 800 Hz ± Hz	± 800 Hz	20 Hz	± 800 Hz	20 Hz
Psophometric Weighted Noise	± 1350 Hz	1740 Hz (Equivalent noise BW)	± 1850 Hz	WTD 3100 Hz
Phase Jitter (on 1010 Hz tone)			± 1850 Hz	3100 Hz
Noise/Tone (Notched noise)			± 1850 Hz	3100 Hz (995-1025 Hz Notch)
Impulse Noise (with notch)			± 1850 Hz	3100 Hz (995-1025 Hz Notch)

*With carrier frequency entry. 800 Hz tone entry may also be made with a resultant change in offset.

3586B SSB Channel Measurement "Menu"

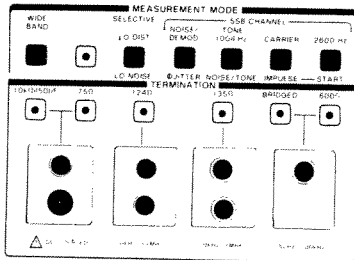

SSB Channel Measurement	3586B (Standard)		3586B (Option 003)	
	Offset From Carrier*	Bandwidth	Offset From Carrier*	Bandwidth
Noise/Demod (Noise or demodulated audio)	± 1500 Hz	2000 Hz	± 1850 Hz	3100 Hz
1004 Hz ± 15 Hz	± 1004 Hz	20 Hz	± 1004 Hz	20 Hz
Carrier	0	20 Hz	0	20 Hz
2600 Hz (Signaling tone)	± 2600 Hz	20 Hz	± 2600 Hz	20 Hz
C-message Weighted Noise	± 1500 Hz	2000 Hz (Equivalent Noise BW)	± 1850 Hz	WTD 3100 Hz
Phase Jitter (1004 Hz tone)			± 1850 Hz	3100 Hz
Noise/Tone (Notched noise)			± 1850 Hz	3100 Hz (995-1025 Hz notch)
Impulse Noise (with notch)			± 1850 Hz	3100 Hz (995-1025 Hz notch)

*With carrier frequency entry. 1004 Hz tone entry may also be made with a resultant change in offset.

Entering the SSB Channel Mode

The 3586A/B uses either a carrier frequency entry, or a test tone frequency as a reference from which offsets are internally computed for the appropriate test. The carrier or test tone frequencies are usually available on an FDM frequency chart.

1. Choose a carrier or test tone frequency reference and press the appropriate entry frequency key.

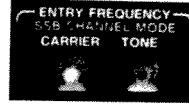

These keys are used only for frequency entry. They do not determine the measurement frequency.

For example, the Channel 1 carrier frequency in a basic group for both CCITT or Bell FDM plans is 108 kHz. (The tone frequency would be 107 kHz (Bell) and 107.2 kHz (CCITT).)

2. Enter the frequency chosen in the ENTRY block.



3. Choose an erect (USB) or inverted (LSB) sideband. For a basic group, the choice is inverted or LSB.



4. Choose any one of the SSB measurements in the MEASUREMENT MODE block.



In this case we have chosen to measure noise on the channel, or to listen to the demodulated audio. The widest bandwidth filter, (1740 Hz, 2000 Hz, or 3100 Hz depending on model or option) is now centered over the voice channel as shown.

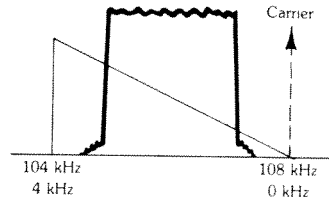

Using the 3586A/B SSB Measurement "Menu"

Once the SSB CHANNEL measurement mode has been entered, the following measurements can be made at a keystroke or two.

(3586A/B)



Idle channel noise with C-message or Psophometric equivalent noise bandwidth, channel power or audio demodulation for listening or further measurement.

(3586A)



Measures 800 Hz or 1 kHz tone level on 3586A instruments. 20 Hz bandwidth is chosen automatically.

(3586B)

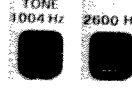

Measures 1 kHz tone or 2600 Hz in band signalling tone with 20 Hz bandwidth.

(3586A/B)



Measures carrier leak with 20 Hz filter to reject an adjacent pilot.

Instruments with Option 003, Transmission Impairments

Note: Tone and carrier measurements are identical on 3586A/B standard and option 003 instruments.



Idle channel noise, channel power, or audio demodulation with 3100 Hz flat filter.

(blue key)



Measures phase jitter on a 1 kHz tone in the channel with .2° p-p resolution. Compatible with BSP 41009 (3586B) or CCITT Recommendation 0.91 (3586A).

(blue key)

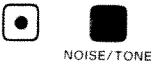

Measures noise on a channel with a 50 dB notch to notch out a 995 Hz to 1025 Hz test tone. Tone is used to activate companders on a telephone circuit for a valid noise measurement.

(blue key)



Initiates impulse noise measurement. Enter a threshold 45 dB or more below full scale in 1 dB steps, and a time period up to 99 minutes, 59 seconds. (0 time determines a continuous measurement.) Press START to begin measurement period. Counts all impulses above threshold during the time interval entered. Compatible with CCITT Recommendation 0.91 (3586A) or BSP 41009 (3586B).



Measures Psophometric weighted noise (3586A) or C-message weighted noise (3586B). A weighted filter is placed in series with the 3100 Hz flat filter.

SSB Measurements with the 3586C

The 3586C Selective Level Meter is designed for general purpose wave analysis and telecommunications measurements and has a simplified front panel. The 3586C is basically the same as the 3586A/B without the SSB CHANNEL measurement mode, carrier or tone ENTRY FREQUENCY, or provisions for impairments measurements. A 50 ohm impedance has been added and 124/135 ohm or 150 ohm removed. The 3100 Hz channel filter is standard on the 3586C.

Although it has a less sophisticated front panel, the 3586C can still be used for the SSB channel measurements of pilot, carrier and tone levels, idle channel noise, channel power, and demodulation. For tone measurements, the frequency of the pilot, carrier, or test tone is entered and measured directly. Use the frequency counter as described above in SELECTIVE MEASUREMENTS and make final measurements with the 20 Hz filter.

Noise and demodulation measurements require a calculation of the proper frequency offset from the carrier.

3586C SSB Measurements

Measurement	Procedure
Carrier	Enter the frequency to be measured directly, use 20 Hz BW. Use the counter and with a wider bandwidth to start if frequency error prevents direct use of the 20 Hz BW.
Pilot Tone	
Test Tone	
Signalling Tone	
Idle Channel Noise	Enter the carrier frequency offset ± 1850 Hz for LSB or USB demodulation. Choose or for proper product detection (demodulation) of the channel. Use the widest bandwidth
Channel Power Demodulation	

Wideband Power Measurements

In the WIDEBAND mode, the 3586A, B or C becomes an RMS power meter with a power level range of -45 to -120 dBm and a frequency range of 200 Hz to 32.5 MHz. The RF energy entering the 50 or 75 ohm input is fed directly to the RMS detector through the RF amplifiers and attenuator without any filtering. Use this mode for measuring baseband power entering a microwave radio link, or integrated signal and/or noise power over any band within the 200 Hz to 32.5 MHz frequency range.

Wideband power accuracy:

200 Hz	10 kHz	10 MHz	32.5 MHz
± 2.0 dB	± 1.0 dB	± 2.0 dB	

Convenience Features

The power of microprocessor control is most evident in the wide variety of operator convenience features available on the 3586A, B and C. In addition to those covered in the previous section, convenience features include:

- Level Offset
- Automatic Level Calibration
- Choice of Measurement Units
- Averaging
- Stepping of Frequency, Full Scale, Time and Threshold Levels
- Analog Frequency Tuning
- Nine Storage Registers
- 10 k Ω /Bridged Inputs
- 10 dB/100 dB Range
- Auto or Entry Full Scale

Level Offset

This powerful convenience feature allows the operator to enter a reference amplitude level and make level measurements relative to the entered reference. Alternatively, a measured level can be entered into offset and subsequent measurements made relatively. This feature speeds harmonic level testing.

Entering an offset level or TLP (Test Level Point) in FDM systems is accomplished by:

- Enter an amplitude level offset up to ± 199.99 dB by pressing in the ENTRY block, followed by the numerical entry, followed by or .
- Turn on OFFSET in the MEASUREMENT ENTRY block.
- The display will show the OFFSET entered.
- Press (now flashing) to resume measurement. The LED display will add the unit suffix "0" to indicate the level display is "offset."

NOTE: If units are changed, a new offset must be entered.

To make a measurement relative to a measured level:

- Measure the level to be used as a reference.
- Press to enter the measured level into offset.
- Press and (now flashing) to resume measurement. Subsequent level measurements will be relative to the measured level entered into offset.

Automatic Level Calibration

When ON, all ranges and bandwidths are calibrated using an external voltage standard. In the LOCAL (non-HP-IB) mode, a CAL occurs once every three minutes, or when the frequency is changed > 1 MHz, at turn-on, or when the CAL is turned off and on. During remote (HP-IB) operation, CAL occurs only for > 1 MHz frequency changes, or when enabled by bus command. If a calibration error is found, a CAL error code is displayed (see Operating and Service Manual for code definition).

Choice of Amplitude Level Units

Use units of dBm (dB relative to 1 mw) for tone or noise level measurements in any impedance. dBpW (dB relative to 1 picowatt) is often used for noise measurements in FDM systems.

0 dBpW = -90 dBm = 0 dBm (dB relative to reference noise) in a 3.1 kHz channel.

dB .775V (dB relative to .775V) is useful for measurements in 600Ω systems.

0 dB .775V = 0 dBm in 600Ω.

The dBm and dB .775V units on the 3586C are identical to the 3586A/B. dB1V (dB relative to 1 volt) units are included in the 3586C for general purpose selective voltmeter measurements in systems using voltage instead of power units.

Averaging

The averaging feature changes the normally displayed five measurements per second to a display of five averaged measurements once per second. Averaging reduces LED level display "racking" caused by externally applied noise, internal noise for small signal measurements near the noise floor, or the beat frequency of closely spaced signals in the bandpass. The accuracy of the averaged measurement depends on the signal to noise ratio and to some extent, the nature of the noise. A noise impulse or spike, for example, could cause a displayed average to be considerably different than previous or subsequent averages.

Stepping Frequency, Full Scale, Offset, Threshold and Time



Stepping Frequency is easily accomplished by:

- Press **FREQ STEP**
- Enter a frequency step from .1 Hz to 32.5 MHz with .1 Hz resolution.
- Press **MEAS O CONT** to return to the frequency display.
- Increment the frequency up or down with **↑** **↓**.

The frequency stepping feature is especially useful for repetitive channel to channel FDM measurements where a 4 kHz step is normally used, in harmonic measurements or frequency response measurements.

Analog Frequency Control

FREQUENCY STEPPING with the FREQUENCY TUNE control is accomplished by entering the frequency step as accomplished above and pressing **FREQ TUNE**. The frequency will be step as the tuning knob is rotated. When **MEAS O CONT** is pressed, the step is automatically chosen as .2, 4 or 20 Hz steps depending on bandwidth.

Bandwidth	Auto Tune Resolution
20 Hz	.2 Hz
400 Hz	4 Hz
1740 Hz	20 Hz
2000 Hz	
3100 Hz	

The FREQUENCY TUNE control is often very useful for fine tuning and manual frequency surveillance such as spur searches.

STEP FULL SCALE SETTING:

- Press **ENTRY** to enter the manual entry mode.
- Press **FULL SCALE** to display the full scale setting.
- Step the full scale setting in 5 dB steps with the **↑** **↓** keys.
- Press **MEAS O CONT** to resume measurement.

STEP OFFSET LEVEL:

- Press **OFFSET** to display the offset level.
- Step the OFFSET level in 1 dB steps with **↑** **↓**.
- Press **MEAS O CONT** to resume measurement.

STEP IMPULSE NOISE THRESHOLD LEVEL: (3586A/B Option 003 only)

- Press **THSHLD** to display the threshold level.
- Step the threshold in ± 1 dB steps with **↑** **↓**.
- Press **MEAS O CONT** to resume measurement.
- The range is ± 199 dB.

STEP IMPULSE NOISE TIME: (3586A/B Option 003 only)

- Press **TIME** to display the impulse noise time period.
- Step the time in ± 1 minute steps with **↑** **↓**.
- Range is 0 to 99 minutes, 59 seconds. (A 0 time entry enables a continuous measurement).
- Press **MEAS O CONT** to resume measurement.

NOTE: The impulse noise threshold and time can be set with the instrument in or out of the impulse measurement mode.

Nine Storage Registers

Nine different front panel settings can be stored in registers 1 through 9 for repetitive testing. The registers are non-volatile so that registers may be recalled indefinitely even after the instrument has been turned on and off. Register 0 permanently contains the instrument turn-on front panel settings.

To store a front panel setting:

- Press **STORE** followed by an integer of 1 through 9. Storing into a previously used register will write over it.

To recall a front panel setting:

- Press **RECALL** followed by an integer of 1 through 9. Recalling another register does not disturb previously recalled registers.

In addition to repeating different measurement configurations, the storage registers can be used to "step" a parameter in non-uniform steps. For example, a pilot frequency sequence in an FDM system.

10 kΩ and Bridged Inputs



75Ω unbalanced inputs (and 50Ω on the 3586C) can be unterminated for high impedance measurements on terminated circuits. This method results in a tapping loss of less than .01 dB when used as shown below.

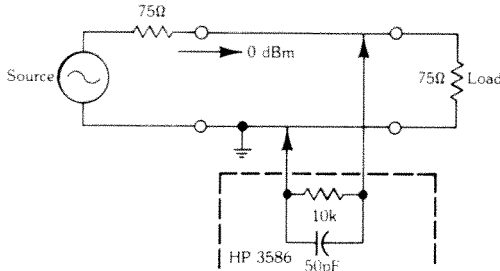

dBm and dBpW measurements will be referenced to the impedance of the input used.

600Ω balanced inputs are unterminated or "bridged" by 10 kΩ and 50 pF when in the BRIDGED mode. Since the impedance ratio is smaller, the "tapping loss" is $- .26$ dB. If desired, the tapping loss can be entered as an offset to correct the measurements.

High-frequency, high-impedance measurements often require an active probe to prevent capacitive loading by the test lead.

10 dB and 100 dB Range

The 10 dB range results in the most accurate level measurements since all signals are automatically ranged to be detected on the most linear region of the Detector/Logger operating range. Resolution is .01 dB on the 10 dB range. This range is most often used.

The 100 dB range selects the entire 80 dB operating range of the internal Detector/Logger, resulting in faster tuning and easier "peaking" of signals when manually tuning. Accuracy is substantially reduced and the resolution is .1 dB in this mode. The 100 dB label for this control refers to the meter scale. This mode is used only when there is an established need for it.

Full Scale Auto or Entry

In the FULL SCALE AUTO mode, the internal gain levels of the 3586 are automatically adjusted for best signal to noise ratio. This mode is used most often.

Full Scale Entry can be chosen for specific operating circumstances such as to eliminate fluctuations caused by a varying signal (use 100 dB range), to eliminate full scale autoranging time in automated production, and to improve signal to noise ratio by over-driving the instrument past a fixed full scale. The latter results in increased harmonic and inter-modulation distortion but can be useful in some applications.

General Purpose Wave Analysis

The innovative nature of our customers makes an exhaustive presentation of SLM applications impractical. Here are a few that may be helpful, or suggest additional applications to you. It is suggested that the preceding section, Basic Measurement Modes, be read prior to this section.

Harmonic Levels

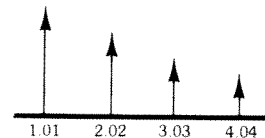

- Measure the fundamental output level of the source (Example, 1.01 MHz, $- 10$ dBm).
- Press Counter followed by **DATA FREQ** to measure and tune to the precise fundamental frequency. Turn the Counter off.
- Enter the fundamental frequency as a frequency step by pressing **FREQ STEP** and entering 1.01 MHz (or the precise counted frequency).
- Press **FREQ** and **↑** successively for the 2nd, 3rd, 4th, etc., harmonic levels.
- To measure harmonics relative to the fundamental, add to step 2 above: Press **RDNG-OFFSET** followed by **OFFSET** and **MEAS-OFFSET**.

Each of the subsequent harmonic levels will be measured in dB relative to the fundamental level.

High Impedance Accessory Probes

The 3586A, B and C Selective Level Meters are designed to operate with the HP High Impedance probes shown below.

Probe power is provided by a front panel connector on the 3586A, B or C.

The use of a high impedance probe allows measurement of levels in terminated unbalanced lines without loading down the circuit significantly.

Other probes may be used with external power supplies if the frequency ranges and connectors are compatible.

SLM Model	Probe Model	Probe Frequency Range	Tapping Loss (75Ω)	Gain	Output Impedance	Connectors
3586A	15880A	20 kHz to 25 MHz	< .15 dB (50 kHz to 20 MHz)	0 ± .2 dB (50 kHz - 20 MHz)	75Ω	BNC
3586B	15880A/004				75Ω	WECO 440A
3586A	15881B	20 kHz to 25 MHz	< .25 dB (50 kHz to 20 MHz)	20 dB ± .2 dB (50 kHz - 20 MHz)	75Ω	BNC
3586B	15881B/004				75Ω	WECO 440A
3586C	1124A	DC to 100 MHz	Input Impedance 10 MΩ/10 pF	X10, X100 ± 5%	50Ω	BNC Input Probe Tip Output

Inter-modulation Products

Inter-modulation products are the result of the mixing of two or more signals in a non-linear element. Since all active networks exhibit non-linearity to some extent, inter-modulation products are always present with two or more signals. Inter-modulation products will occur at sum and difference of the fundamental and harmonic frequencies, i.e., at $mf_1 \pm nf_2$ when two signals are present. The two most common sets of inter-modulation products of concern are 2nd order ($f_1 \pm f_2$), and 3rd order ($2f_1 - f_2$ and $2f_2 - f_1$). [$(2f_1 + f_2)$ and $(2f_2 + f_1)$ are normally too high in frequency to be of concern.]

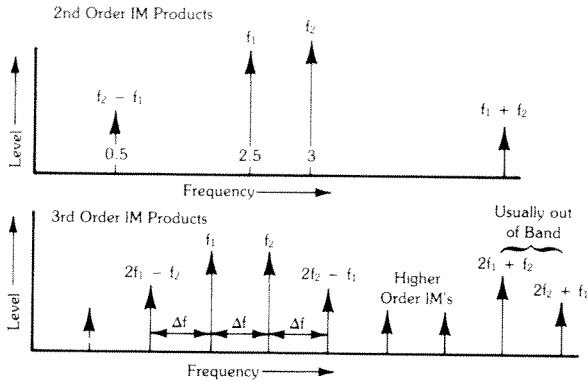

The relative level of IM products compared to the fundamental levels is an important measure of the linearity and filtering properties of a test network. Note that f_1 and f_2 do not have to be at the same level, although they usually are for measurement convenience.

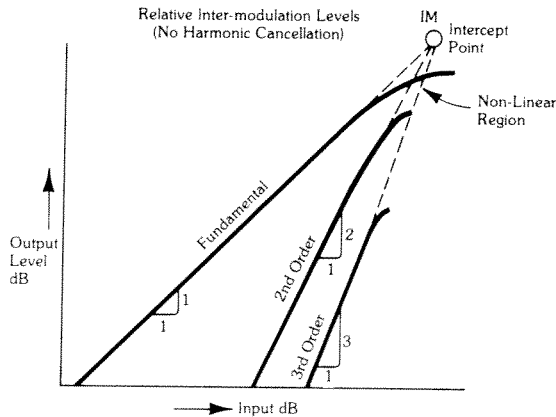

The input/output characteristics and relative IM levels of a typical active network is shown above. Inter-modulation products are often specified in terms of an intercept Point output level, or in a specified IM level for specified fundamental levels. (If harmonic cancellation is present in a network then the 2nd and 3rd order intercept points can be at different levels, for example, in a balanced mixer.)

Measuring Inter-modulation Products with the 3586A/B/C

Inter-modulation measurements are made quickly and easily by taking advantage of the frequency step, storage registers, counter, and offset features of the HP 3586 SLM.

2nd Order IM Measurement:

- Connect as shown.
- Enter the frequency of the fundamental signal, f_1 , used as a reference.
- Choose a bandwidth smaller than the spacing between the two test signals so only one at a time will be measured.

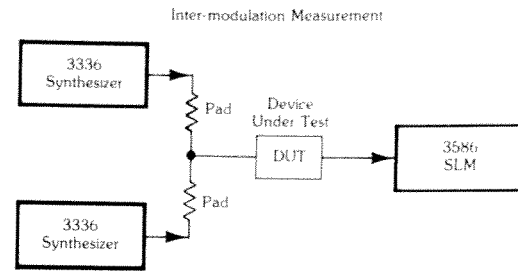

- Use the COUNTER and $\text{CENTR} \rightarrow \text{FREQ}$ to count and tune precisely to the reference signal frequency.
- Change bandwidth to 20 Hz (or wider if the frequency stability is $> \pm 3$ Hz).
- Press $\text{HOLD} \rightarrow \text{OFFSET}$ and turn on OFFSET for measurements relative to the fundamental. (Delete if readings are desired in absolute level.)
- Press STORE and 1 to store the f_1 settings.
- Enter the frequency of f_2 and STORE the f_2 setting in register 2. Use $\text{CENTR} \rightarrow \text{FREQ}$ if required.
- Enter the frequency of $f_1 + f_2$ and STORE in register 3.
- Enter the frequency of $f_1 - f_2$ and STORE in register 4.
- Each of the frequencies may be measured again by pressing $\text{RECALL} \rightarrow \text{R}$ and the appropriate storage register.
- Note that if the reference frequency level OFFSET is changed, the new OFFSET value must be re-entered into each storage register if the registers are used for repetitive measurements.

3rd Order IM Measurement

This measurement is simplified by the fact that inter-modulation products are spaced ΔF from the fundamental signals, where ΔF is the spacing between the two fundamental signals.

- Enter the frequency of f_1 , use the widest bandwidth.
- Press COUNTER and $\text{CENTR} \rightarrow \text{FREQ}$, and reduce bandwidth to 20 Hz if signal stability permits.
- For relative measurements, press $\text{HOLD} \rightarrow \text{OFFSET}$ and turn on OFFSET.
- Enter a $\text{FREQ} \rightarrow \text{STEP}$ equal to the difference frequency.
- Step up or down sequentially to measure each IM product or f_2 , step to each product and/or STORE in separate registers.

Measurement Limitation

- Internally generated IM products in the 3586 are specified at 75 dB below full scale for ΔF 20 kHz to 1 MHz, and 70 dB for ΔF 200 Hz to 20 kHz. To maintain these specifications, use FULL SCALE AUTO and stay within the 3586 SLM amplitude range.
- Sufficient isolation between test sources must exist to reduce IM products caused by cross talk between test sources.
- Fundamental signal levels must be set accurately to obtain best measurement accuracy since IM levels change by 2 or 3 times the fundamental level change.
- Test source harmonic levels must be 10 dB lower than harmonic levels generated in the device under test for accurate results. Use low pass filters, if necessary.

Modulation Distortion

It is often desirable to measure the harmonic levels generated by AM or SSB modulation of a transmitter. This is most easily accomplished by modulating the transmitter at rated modulation (usually 80 to 100 percent) with a test source with harmonic output well below the desired specification. (An HP 239A Low Distortion Oscillator is an ideal audio test source since harmonic levels are 90 dB down to 20 kHz.) The 3586 SLM can then measure the modulation tone fundamental and harmonic levels.

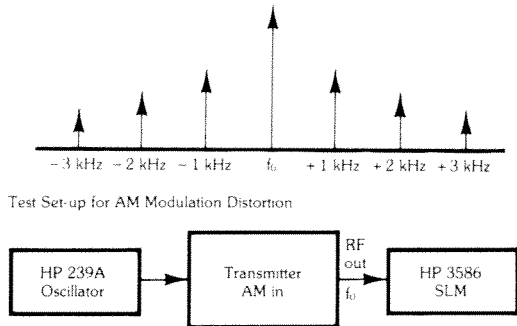

- Set the output of the test oscillator to the audio level required for rated modulation at 1 kHz.
- Enter the RF frequency plus 1 kHz into the 3586 SLM for AM or USB modulation, or minus 1 kHz for LSB modulation.
- Measure the 1 kHz sideband level using the 20 Hz filter. Manual tuning may be required to peak the 20 Hz filter on the sideband.
- Use the COUNTER and $\text{CSTR} \rightarrow \text{FREQ}$ to tune precisely to the sideband.
- Press $\text{FREQ} \rightarrow \text{OFFSE}$ and turn on OFFSET to reference readings to the fundamental sideband level.
- Enter a $\text{FREQ} \rightarrow \text{STEP}$ of 1 kHz.
- Measure modulation harmonic relative levels using to step to each harmonic.
- % modulation (envelope) distortion can be calculated as follows:

$$\% \text{ distortion} = 100 (\text{antilog } A_{1/10} + \text{antilog } A_{2/10} + \dots + A_{N/10})$$
 Where A_N is the relative level of the Nth harmonic in dB (power).

Measurement Limitation:

- The inter-modulation suppression of the 3586 SLM is 70 dB below full scale.
- The harmonic suppression of the test oscillator should be 10 dB better than the desired spec level.
- The modulation level for rated % modulation must be accurately known to achieve accurate results.

Spurious and Other Signals Close to the Noise

Spurious signals from an active network are generally unwanted signals that are not harmonically related to the output signal and may exist at the output with or without a signal present.

Spurious with signal are often caused by modulation of the output by the 50/60 Hz line frequency and harmonics or by modulation or inter-modulation of the output with other internally generated signals such as 20 kHz power supply switching frequencies or local oscillator fundamental and harmonic out-

puts. Spurious outputs without signal are the same internally generated signals, not mixed with or modulating the output signals.

Another type of spurious is caused by an oscillation of a part of the test network which may or may not require a signal to excite it.

In a well-designed network, spurious signals are generally close to the noise and, therefore, require careful measurements for accurate results.

Guidelines for spurious testing:

- Store known spurious frequencies in storage registers for quick recall.
- Use the LO NOISE mode to reduce the noise floor by up to 5 dB when the FULL SCALE setting is greater than -35 dBm.
- Use the narrowest bandwidth possible consistent with the spurious frequency stability. This will usually establish the lowest noise floor and best selectivity.
- Use AVERaging to reduce LED display racking. Note that the averaged reading can be higher than the actual signal level due to the addition of averaged noise when the signal is close to the noise.
- Note that the noise floor can exceed minimum levels if the FULL SCALE setting is too high. For example, with 20 Hz bandwidth, the noise floor above 100 kHz is -120 dBm for a FULL SCALE setting of -35 dBm or lower, but is specified at 80 dB down (-90 dBm in for -30 dBm full scale) for higher FULL SCALE settings.

Noise Floor (Full Scale setting -35 to -120 dBm):

Frequency	Bandwidth	Noise Level
100 kHz to 32.5 MHz	3100, 1740, or 2000 Hz	-116 dBm
10 kHz to 100 kHz	20 Hz, 400 Hz	-120 dBm
	All Bandwidths	-105 dBm

The noise floor for full scale settings of -30 to +25 dBm is 80 dB below full scale for > 100 kHz, and 60 dB below full scale for < 100 kHz.

- The FULL SCALE setting is determined in AUTO by the total power entering the 3586 front end. If this setting results in the noise floor exceeding the desired level, some improvement is possible by allowing the input to be overdriven. To achieve this improvement, the FULL SCALE setting in AUTO must be < -50 dBm, > -105 dBm if the 10 dB range is used, or < -35 dBm if the 100 dB range is used. (The 100 dB range sacrifices measurement accuracy.) If the above conditions are met, choose the 10 dB or 100 dB range and follow these steps:
 - Find the FULL SCALE in AUTO by pressing $\text{FULL} \rightarrow \text{SCALE}$.
 - Change to FULL SCALE ENTRY mode and enter a FULL SCALE 5 dB lower. This reduces the noise floor 5 dB (for FULL SCALE settings > -105 dBm).
 - Continue reducing the FULL SCALE SETTING as long as the reading drops. The lowest level reading occurs when the signal to noise ratio is the highest.

Measurement Limitation

When using the above overdrive procedure, the inter-modulation and harmonic performance of the 3586 SLM will be degraded. This will only be a problem when inter-modulation or harmonic signals fall near a desired measurement frequency, inside the bandwidth chosen.

Frequency Response Testing Using the Tracking Output

The 3586 SLM includes a rear panel tracking output of 0 dBm ± 0.5 dB, at the passband center frequency. The flatness is ± 0.5 dB referenced to 10 kHz and harmonics are typically 30 dB down.

The output frequency has the same accuracy and stability and resolution as the center frequency specifications.

The tracking output can be used for frequency response testing of active or passive networks using the test set-up shown below.

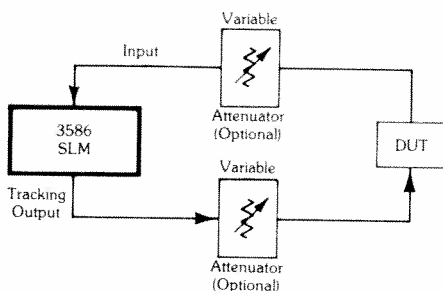

The optional variable attenuators can be used to adjust the input and output levels to acceptable ranges, if required. The attenuation level required can be entered into OFFSET for display of the actual gain or loss of the network under test.

Since the frequency resolution is .1 Hz, high-Q filters and other selective networks can be tested using this approach.

Frequency Response Testing Using a Tracking Synthesizer

Frequency response testing of active or passive networks can be performed with an external tracking synthesizer, HP Model 3336A/B/C or 3335A Synthesizer/Level Generators. The 3586A/B/C SLM and the tracking synthesizer are put in the frequency tracking mode by connecting their HP-IB interface connectors with an HP 10631 Series cable and setting the REM/TRK switch on the rear panel of the 3586 SLM to TRK, and the 3336 SLG switches to listen only. This puts the SLM in the TALK ONLY mode so that the tracking synthesizer frequency will automatically be programmed to the SLM frequency.



While frequency response measurements can be made with the built-in tracking output as described in the preceding section, the tracking synthesizer offers a number of measurement advantages including:

- Amplitude flatness and accuracy with full range control (No external attenuator required)
- Substantially better spectral purity
- Remote frequency tracking capability for telephone circuit loop or end-to-end testing.

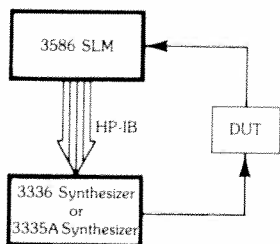

Use the 3336A, B or C Synthesizer/Level Generator for frequency tracking to 20.9 MHz, or choose the 3335A Synthesizer/Level Generator for full frequency coverage to 32.5 MHz. While any model or option of the two synthesizers will frequency track with any 3586 SLM model, care should be taken to insure connector/impedance compatibility between the two.

Selective and Wideband Noise Measurements

The true RMS detector used in the 3586A, B and C Selective Level Meter allows accurate, selective noise or channel power measurements in the SELECTIVE measurement mode, or WIDEBAND noise or power measurements.

RMS vs. Average Detection

Average detection has been traditionally used for noise detection since it is a less costly approach. For purely gaussian noise, this works out fairly well providing a 1.05 dB correction is added to compensate for the lower average noise power reading. Unfortunately, this correction factor changes for complex waveshapes, – for example, the noise in a telephone channel. Consequently some error will result, an error that is unfortunately not predictable.

The RMS detector used on the 3586A, B and C SLM will measure the RMS value of any waveshape with a crest factor up to 5:1, or noise characteristics, so it is not subject to the unpredictable error of the average detector and is therefore a more accurate approach to noise measurement.

Selective Noise Measurements

Noise or channel power measurements can be made in any bandwidth, but are most often made in the telephone voice channel bandwidth of 3100 Hz, with or without C-message or psophometric weighting, or in 1740 Hz or 2000 Hz equivalent weighted noise bandwidths. (See page 21 for a C-message and psophometric weighted noise measurement and equivalent noise bandwidth discussion.)

Generally speaking, the SLM measures the total power in the bandwidth chosen, both noise and discrete signal power. Therefore, the guidelines provided above in the BASIC MEASUREMENTS section generally apply. Units of dBpw (dBm) may be used. (0 dBpw = 0 dBm = -90 dBm in 3.1 kHz BW.)

Specific guidelines for selective noise measurements are:

- Use AVE (averaging) to reduce display racking.
- Use the LO NOISE (low noise) mode.
- Use the spurious testing guidelines on page 17 for using full scale overdriving to further reduce the noise floor if necessary.
- Remember that the noise power measured is directly proportional to the noise bandwidth of the filters used. The noise bandwidth of the 3100 Hz, 1740 Hz, 2000 Hz or 400 Hz filters used on the 3586A, B or C SLM can be considered to the 3 dB bandwidth for most applications. This is true only for very selective (low shape factor) filters.
- To convert noise power measured in a bandwidth to that measured in another bandwidth, use the relationship:

$$N_{(BW_1)} \text{ in dBm} = N_{(BW_2)} + 10 \text{ LOG } \frac{BW_1}{BW_2} \text{ dBm}$$

For additional information on noise measurements, see page in the FDM Systems Measurements section.

Wideband Noise and Power Measurements

The 3586A, B or C becomes an RMS power meter in the WIDEBAND measurement mode with a frequency range of 200 Hz to 32.5 MHz. All noise and signal power within the frequency range is measured, with an amplitude range of -45 to $+20$ dBm. Power entering the input passes through the RF input attenuator and RF gain stages and is connected directly to the RMS detector, bypassing all frequency conversion and frequency selective circuitry.

The WIDEBAND measurement mode is most often used for baseband power measurements between the output of a Frequency Division Multiplex system and the input to a microwave radio.

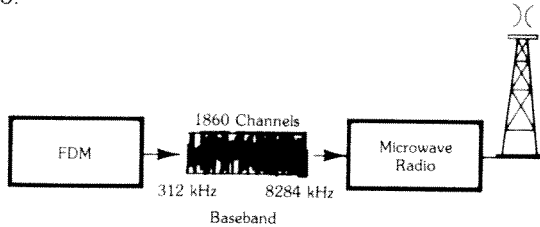

Wideband Power Accuracy:

After calibration, 100 dB range, averaging on -45 to $+20$ dBm.

200 Hz	20 kHz	10 MHz	32.5 MHz
± 2.0 dB	± 1.0 dB	± 2.0 dB	

Return Loss

Accurate return loss measurements can be made using an external return loss bridge and the 3586A, B or C SLM. The SLM is used for a frequency selective, accurate detector. The signal source can be the tracking output of the SLM (for unbalanced measurements), or an external precision level generator, such as the HP 3336A, B or C or the 3335A Synthesizer/Level Generators, for improved accuracy and for all balanced measurements.

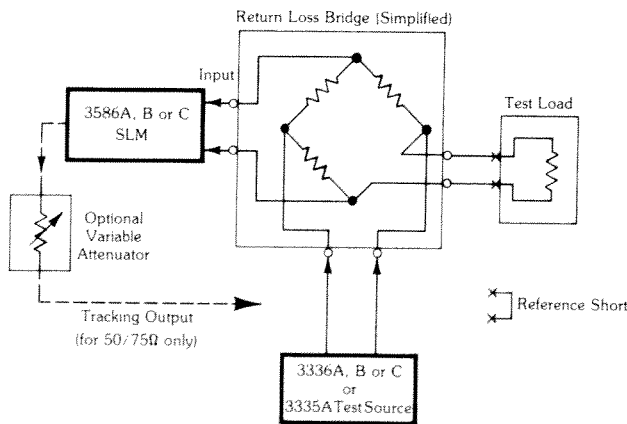

The following return loss bridges are available from HP:

Impedance	Return Loss Bridge
50Ω	8721A
75Ω	8721A Opt. 008
124Ω	5061-1136
150Ω	5061-1135

The signal from the test source is delivered to the test load through the return loss bridge with typically 6 dB loss. Any impedance difference between the bridge balancing impedance and the impedance of the test load results in an unbalanced condition. Reflected power from the test load mismatch is then directed to the 3586 SLM. The difference between the reflected power from the test load and the power reflected from a short or open reference impedance is the return loss.

The 3586A, B or C SLM is often the best choice for return loss testing since harmonics and spurious signals generated by the test network outside the bandwidth are rejected by the highly selective bandpass filter characteristics.

Procedure:

- Set the test source output to a level compatible with the test load dynamic range.
- Connect a reference short to the test port of the return loss bridge. The test signal will be reflected back to the SLM less the path loss through the bridge.
- Set a 0 dB return loss reference by measuring the reflected level in the SELECTIVE mode with the narrowest bandwidth compatible with the test source stability.
- Set the measured reference level to a 0 dB return loss reading on the 3586 SLM by pressing **RDNG-OFFSET** and turning on OFFSET.
- Replace the reference short with the test load. The return loss in dB will be displayed by the 3586A, B or C SLM.

Measurement limitations:

- The directivity of the return loss bridge must be significantly greater than the return loss measured. For example, the measurement uncertainty of a 30 dB return loss measurement with a bridge directivity of 40 dB is approximately ± 3 dB.
- The input test signal must be compatible with the dynamic range of the test load. The return loss (or input impedance) of an active network such as a transistor amplifier or mixer changes with input power if tested at levels exceeding linear operation.
- Use a bridge with the same connector type and impedance as the test load to prevent mismatch uncertainties.
- Make sure that the reflected level measured is sufficiently above the SLM noise floor for accurate measurements.

Measurements on FDM Systems

The 3586A/B Selective Level Meter and the 3336A/B Synthesizer have been designed with many features to meet exacting FDM system measurements. Worldwide impedances and connectors are available by model, option or special order to meet CCITT and North American (Bell) requirements. Microprocessor design allows many measurements to be made at a keystroke with operator convenience such as level offset, choice of units, frequency counter, analog tuning/stepping and storage registers available to reduce measurement time.

A significant contribution is the ability to make transmission impairment measurements on 3586A/B Option 003 models at both voice grade and carrier frequency for troubleshooting comparisons.

The 3336A, B & C Synthesizer Level/Generator brings a combination of frequency resolution, spectral purity, and amplitude level precision not previously available. Additional features include worldwide impedances and connectors, wide-band phase continuous sweep, phase offset, AM/PM modulation and frequency tracking compatibility with the 3586A, B and C SLM.

This section is a synopsis of basic FDM measurements methods using the 3586A, B and C Selective Level Meter and the 3336A, B and C Synthesizer/Level Generator. The reader should be familiar with Chapter IV, Basic Measurements, and optionally, General Purpose Applications starting on page 27 before proceeding with this chapter.

3586A CCITT

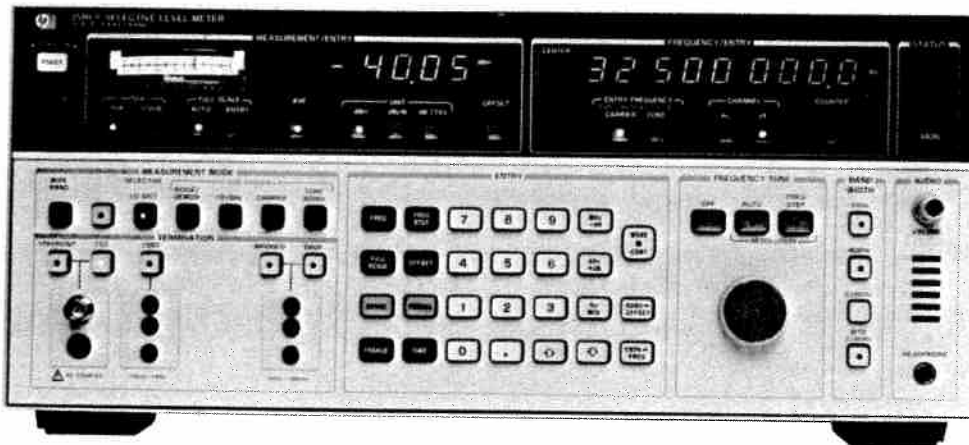

3586B No. American (Bell)

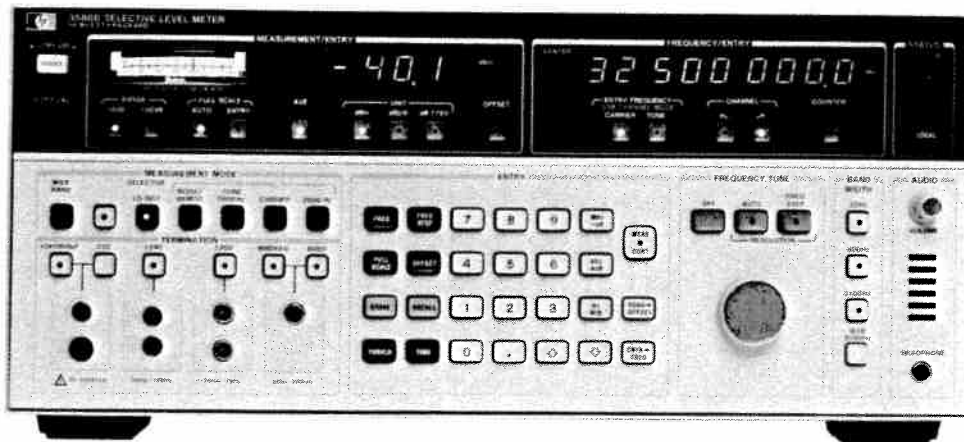

Shown with
Option 003
Transmission
Impairments

FDM Channel Measurements at a Keystroke

The following measurements can be made by simply entering the SSB CHANNEL measurement mode and pressing the appropriate key.

3586A CCITT	3586B No. American (Bell)
1 kHz and 800 Hz tone level	1 kHz tone level and 2600 Hz signalling tone level
<ul style="list-style-type: none"> • Idle channel noise, audio demodulation, channel power 	
<ul style="list-style-type: none"> • Carrier leak 	
<ul style="list-style-type: none"> • Baseband Power 	
Psophometric equivalent weighted noise (1740 Hz)	C-message equivalent weighted noise (2000 Hz)
with Option 003 Transmission Impairments	
<ul style="list-style-type: none"> • Phase Jitter on 1 kHz tone 	
<ul style="list-style-type: none"> • Noise-with-tone (Signal to noise with tone ratio) 	
<ul style="list-style-type: none"> • Single level impulse noise with or without 1 kHz tone 	

NOTE: Start all procedures from the turn-on condition. Use RECALL 0 to set this condition.

Entering the SSB Channel Measurement Mode

(See Basic Measurements, page 11 for details)

Choose an 800 Hz (3586A) or 1004 Hz (3586B) test tone frequency or carrier frequency reference from an FDM plan chart that applies to the channel you wish to measure. For example, 108 kHz is the carrier frequency for channel 1 of a basic group, or 107 kHz is the 1 kHz test one frequency (3586B) or 107.2 kHz is the 800 Hz test tone frequency (3586A).

Enter this frequency and press CARRIER or TONE ENTRY as appropriate.

This enters the frequency as a reference frequency for SSB channel alignment. It is not necessarily the frequency the passband is tuned to.

- Choose an erect (∧) or inverted (∨) channel as required.
- Press any one of the four keys in the SSB CHANNEL measurement mode.

The channel filter will be aligned on the voice channel if NOISE/DEMOD is pressed, or the 20 Hz filter will be aligned on the tone or carrier frequency chosen.

Channel Filters provided:



3586A		3586B	
Standard	Option 003	Standard	Option 003
1740 Hz (Psophometric Noise Equivalent)	3100 Hz, Wtd. 3100 Hz	2000 Hz (C-Message Noise Equivalent)	3100 Hz, Wtd. 3100 Hz

Precise Channel Alignment with the Frequency Counter

Frequency errors between the measured tone and the center frequency of the 3586A/B SLM can be eliminated by using the COUNTER and  keys.

The counter measures and displays the frequency of the strongest signal in the 3588 SLM passband to ± 1.0 Hz accuracy. The "counter to center frequency" key tunes the precise center of the passband to that frequency. Use this feature when entering the SSB CHANNEL measurement mode by counting and tuning to either the test tone or carrier frequency used for SSB channel mode entry.

Procedure:

- After entering the SSB CHANNEL mode as described in the section above, measure the carrier leak or test tone level used for entry by pressing CARRIER or TONE as appropriate.
- Press COUNTER and the precise frequency of the carrier leak or tone used will be measured and displayed.
- Press  to tune the center of the passband precisely to the measured frequency.
- Press  to resume previous measurement.

The channel filter is now precisely tuned on the channel. No further tuning is required.

Test Tone Level:

- Press 800 Hz or 1010 Hz (3586A); or 100 Hz (3586B) the test tone level will be displayed.

2600 Hz Signalling Tone Level (3586B):



- An in-band signalling tone at 2600 Hz is measured by pressing the 2600 Hz key. The 20 Hz filter is used.

Carrier Leak

- The carrier leak level is measured by pressing . The 20 Hz filter is used. An adjacent pilot is rejected 50 dB.

Transmission Level Point (TLP Reference)

A TLP or any other level within the range can be used as a level reference. The TLP is entered as an OFFSET and subsequent measurements are made in dBm.

- Enter the TLP by pressing  and entering the TLP level (between ± 199.99 dBm). Turn on OFFSET. The display will read 00.00 dBm0.
- Press  to resume previous measurement. Level is displayed in dBm0.

Noise and Demodulation

Idle channel noise, channel power, demodulated audio on speaker output or 600 ohm front panel output are all enabled by pressing . The 1740 Hz filter (3586A), 2000 Hz filter (3586B) or 3100 Hz filter (3586A/B Option 003) is aligned precisely on the channel. Voice, tones or noise can be heard on the speaker by turning up the volume control.

Noise level can be measured in dBm or dBpW. (Remember 0 dBpW = 0 dBm = -90 dBm in a 3100 Hz bandwidth.)

Equivalent Weighted Noise

Psophometric equivalent noise is measured in a 1740 Hz bandwidth automatically on the standard 3586A when 1740 Hz is pressed. The same key chooses the 2000 Hz C-message equivalent bandwidth on the standard 3586B.

The 1740 Hz filter (standard on the 3586A) provides psophometric equivalent weighted noise measurements for CCITT FDM systems. It is offset ± 1350 Hz from the carrier in the SSB mode and can also be used for general purpose demodulation with reduced bandwidth.

The 2000 Hz filter (standard on the 3586B) provides C-message equivalent weighted noise measurements for systems meeting North American (Bell) requirements and is offset ± 1500 Hz from the carrier in the SSB mode. The 2000 Hz bandwidth, combined with the RMS detector used, provides a more accurate C-message noise equivalent bandwidth than the conventionally used 1740 Hz equivalent noise bandwidth. The 2000 Hz filter also has the additional advantage that more of the channel is demodulated. The 1740 Hz filter is available as an option on the 3586B; some users will want to maintain historical continuity with past data.

Direct weighted noise measurements can be made with the weighted response filter and a 3100 Hz channel filter available as part of Option 003.

Equivalent Weighted Noise Bandwidth

Psophometric or C-message weighted noise measurements are often made with a filter having noise bandwidth equivalent to the noise bandwidth of a filter having the precise frequency response for psophometric or C-message requirements. This approach has the advantage that a conventional bandpass filter can be used for the weighted noise measurement instead of a more costly noise weighting filter with its special frequency response. The disadvantage is that the equivalent weighted noise filter is accurate for white noise only and does not completely cover the voice band of 300 to 3400 Hz.

The equivalent noise bandwidth of a filter is the bandwidth of an ideal rectangular filter that passes the same noise power as the non-ideal filter. Filters with relatively little selectivity will have an effective noise bandwidth (ENBW) that is wider than the 3 dB bandwidth.

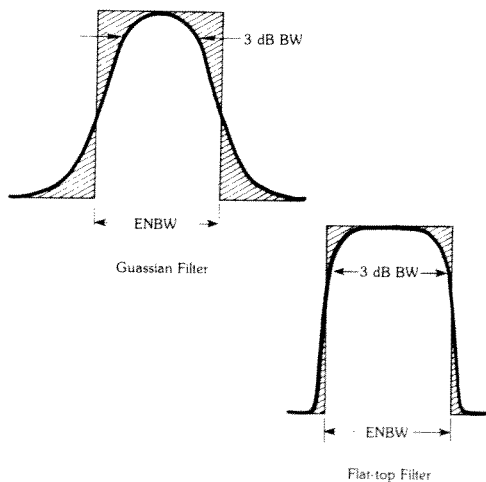

A flat top filter response more closely approximates an ideal filter and so have an ENBW closer to its 3 dB bandwidth. If a flat top filter has sufficient selectivity, (i.e., is almost ideal) then the 3 dB bandwidth and ENBW are virtually identical. This is the case with the 1740 Hz or 2000 Hz equivalent noise filters on the 3586A/B.

1740 Hz vs. 2300 Hz vs. 2000 Hz ENBW

Older selective level meters using average detection used a 2300 Hz bandwidth filter with an ENBW of 1740 Hz – the ENBW of a psophometric weighted noise filter. These filters were often on the instrument front panel as "2300 (1740) Hz." For purely white noise and psophometric weighting, this approach yielded reasonable, but somewhat erroneous results.

Measurements of C-message equivalent weighted noise often are made with the 1740 Hz ENBW filter since it approximates C-message weighting, although a -0.5 dB error results.

The 3586A/B uses RMS detection and a 1740 Hz ENBW filter for psophometric equivalent weighted noise measurement. A 2000 Hz ENBW filter is used for C-message equivalent noise to precisely provide the proper noise weighting, thereby eliminating the 0.5 dB error. The ENBW of the 1740 Hz and 2000 Hz filters used in the 3586A/B are the same as their 3 dB bandwidths as a result of their excellent selectivity.

The 2000 Hz C-message noise equivalent filter has another advantage over using the 1740 Hz filter – more of the telephone channel is covered by the filter so there is less chance of high frequency noise affecting the measurement. For those needing to correlate with past test data, the 1740 Hz filter is optional on the 3586B.

Frequency Stepping for Repetitive Channel Measurements

Repetitive channel measurements such as carrier leak or tone level measurements can be quickly made on a channel to channel basis by simply entering the SSB CHANNEL measurement mode as described above and using the FREQUENCY STEP feature with 4 kHz steps. (Any step from .1 Hz to 32.5 MHz may be entered.) Step tuning is accomplished with incremental step keys \leftarrow \rightarrow , or the FREQUENCY TUNE CONTROL.

Procedure:

- Press **FREQ STEP** and enter the frequency step desired.
- Press **FREQ**
- Use \leftarrow \rightarrow to step incrementally up and down in frequency.
- Alternatively, press **FREQ STEP** in the FREQUENCY TUNE block and use the tuning knob.

The step keys are also used to step several other functions. See page 14.

Pilot Tone Level

Pilot tones are measured with respect to TLP, in the SELECTIVE MODE with the 20 Hz bandwidth. The adjacent carrier leak 80 Hz away is rejected at least 50 dB.

Pilot frequencies can be entered directly, or nine pilot frequencies can be stored in the storage registers for later recall. Alternatively, an 80 Hz frequency step can be used to step to a pilot frequency from a carrier measurement. The 80 Hz step can be stored in one storage register and the 4 kHz carrier step in another.

Baseband Power

The WIDEBAND measurement mode is used to measure the baseband power input to a microwave radio. In this mode the 3586A/B is an RMS power meter measuring the total power instantaneously over the 200 Hz to 32.5 MHz frequency range with an amplitude range of -45 to +20 dBm. See page for additional information.

Transmission Impairments Measurements with Option 003

Instruments with Option 003 included make all these additional impairments measurements at voice frequency and carrier frequency. All are made through the 3100 Hz channel filter included in Option 003.

- Phase jitter
- Weighted Noise with 3100 Hz channel filter and direct weighted noise filter.
- Noise-with-tone (Notched noise)
- Signal to Noise-with-tone Ratio
- Single level impulse noise

For the first time, impairment measurements can be made on voice frequency circuits and compared with measurements made at carrier level. This allows more complete troubleshooting – and with one instrument.

Phase Jitter

Phase jitter measurements can be made on any signal up to 32.5 MHz, -65 dBm minimum (or lower with reduced accuracy), that can be demodulated to 990-1030 Hz in the voice channel. The resultant phase jitter is filtered with a band-pass of 20 to 300 Hz as required by CCITT Recommendation 0.91 and BSP 41009. Accuracy is $\pm 10\%$ plus a residual phase jitter of 0.5° p-p.

Example:

Measure the phase jitter on a 1010 Hz tone in channel 1 of a basic group.

- Press TONE FREQUENCY ENTRY .
- Enter a tone frequency of 106.990 kHz, (the frequency of a 1010 Hz tone in channel 1).
- Choose an inverted channel .
- Press PHASE JITTER .
- Read display in degrees p-p

To measure phase jitter on a carrier simply enter the carrier frequency as if it were a TONE FREQUENCY. This method is used to measure phase jitter on any frequency up to 32.5 MHz.

Weighted Noise Measurements

Psophometric (3586A) or C-Message (3586B) weighted noise measurements are made by superimposing the weighted filter characteristic over the 3100 Hz channel filter.

The measurement is made in the single sideband mode by entering the channel carrier or tone frequency, choosing inverted or erect channel and pressing $\frac{3100}{\text{OFFSET}}$. The 3100 Hz channel filter is automatically chosen in NOISE/DEMODO. Use units of dBpW for noise measurements in dBpWP or dBBrnC, use the offset feature for measurements in dBpWPO or dBBrnC0.

Noise with Tone

Noise measurements on a channel with a 995 to 1025 Hz tone present, (notched noise) can be made by following the procedure for weighted noise except the blue key $\frac{3100}{\text{OFFSET}}$ is pressed followed by $\frac{3100}{\text{OFFSET}}$ to activate the notch filter. The filter is compatible with CCITT Recommendations and BSP 41009 requirements and provides 50 dB rejection. The measurement can be made with or without noise weighting.

Signal to noise-with-tone ratio measurements are easily made by using the amplitude offset feature.

Example:

Measure the tone level, press OFFSET $\frac{3100}{\text{OFFSET}}$, and $\frac{3100}{\text{OFFSET}}$. This references subsequent measurements to the signal level.

Measure noise-with-tone as described above.

The display will read the signal to noise-with-tone ratio directly in dB.

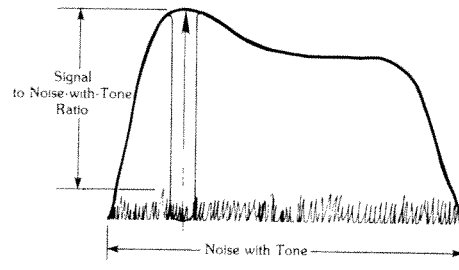

Impulse Noise

Measure single level impulse noise at any frequency up to 32.5 MHz with the 3100 Hz bandwidth. The measurement can be made with or without a 1010 Hz ± 15 Hz tone present. The notch filter is automatically inserted. The threshold level can be set in 1 dB steps from 0 to 50 dB below full scale, or greater than -80 dBm. Counting accuracy is 1 dB, and the time period can be set from 1 to 99 minutes, or continuous. To make an impulse noise measurement, enter the SSB CHANNEL measurement mode by entering the carrier or tone frequency and $\frac{3100}{\text{OFFSET}}$ or $\frac{3100}{\text{OFFSET}}$ for the channel chosen and press the blue key and IMPULSE. Press THSHLD and enter a threshold level from 0 to 50 dB below full scale. Press TIME and enter 1 to 99 minutes, or enter 0 minutes for a continuous time duration. Press $\frac{3100}{\text{OFFSET}}$ to begin the measurement. Pressing START a second time will terminate the measurement prior to the completion of the time duration entered. Impulses greater than the threshold level will be counted up to a maximum of 999 counts. Impulses wider than 125 ms (3586A) or 143 ms (3586B) will result in multiple counts.

Slot Noise, Noise Power Ratio (NPR)

Slot Noise Measurements

Noise measurements are often made in unused frequency bands or "slots" between groups or supergroups. This measurement is often called "intergroup" or "intersupergroup" noise. This measurement provides a measure of the noise performance of an FDM system under loaded conditions. Slots are typically 48 to 56 kHz wide. One or two channel widths on both sides of the slot are not used. Unweighted noise levels are measured in ten "channels" in the center of the slot and the results averaged. A typical slot is shown below.

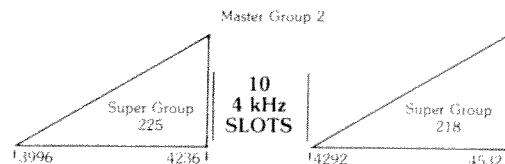

This measurement is easily made with the 3586A/B in the SSB CHANNEL NOISE/DEMODO mode using 4 kHz steps.

Noise Power Ratio (NPR)

Since an FDM system contains a very large number of signals, it is not practical to measure inter-modulation products on a signal-by-signal basis. The NPR test was developed to provide a measure of inter-modulation and thermal noise levels by simulating system loading with white noise. NPR is defined as "the ratio, expressed in decibels, of the noise in a test channel with all channels loaded with white noise to noise in the test channel with all channels except the test channel fully noise loaded."¹ It can be shown that white noise loading the FDM system will cause noise simulating inter-modulation noise to appear in the test channel (in addition to thermal noise) with the noise load input rejected in that channel only.

The test is usually performed on a baseband-to-baseband basis with the white noise generator providing a noise power of $P(\text{dBm0}) = -15 + 10 \log N$ for $N > 240$ channels. High pass and low pass filters allow only noise in the FDM frequency range to be applied. The selective level meter is used to measure the noise in the test channel under the two conditions. The test channel frequencies are specified in CCIR REC. 399-1 and according to number of channels and the band limits.

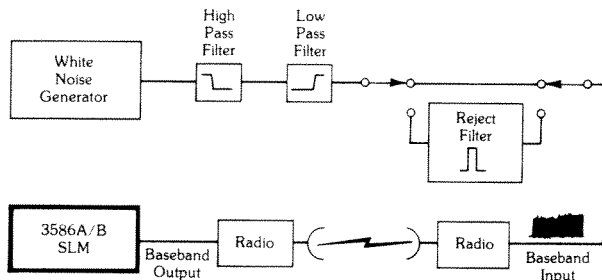

After the proper noise generator output is determined according to the number of channels and band limits, the 3586A/B SLM is used as follows:

- Use CARRIER or TONE FREQUENCY ENTRY and SSB CHANNEL NOISE/DEMODO measurement mode to set the channel filter on the test channel with the band reject filter on the noise generator enabled.
- Press **RDNG** and **OFFSET** to establish the measured level as a reference.
- Disable the noise generator reject filter. The display now reads the NPR in dB.

Cross Talk Measurements²

Crosstalk in a telephone system can be defined as "the presence in a telephone receiver of unwanted sounds from another telephone conversation." There are three causes of both intelligible and non-intelligible crosstalk in an FDM system. The first is non-linear performance resulting in inter-modulation products. Second is poor frequency response caused by poor filter selectivity or alignment. The third is direct coupling between transmission media. Generally, noticeable crosstalk should be present in less than 1% of phone circuits randomly connected to a subscriber.

Non-linear performance is measured by inter-modulation or NPR measurements. Both poor filter selectivity and direct coupling can be measured by introducing a tone in a test channel and then measuring the level in adjacent channels where adjacent may mean in the same group (close in frequency); or adjacent physically, such as capacitive or inductive coupling of circuits in a common cable.

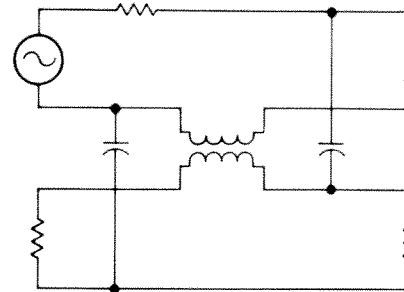

Inductive and Capacitive Coupling Crosstalk of Adjacent Circuits on a Cable

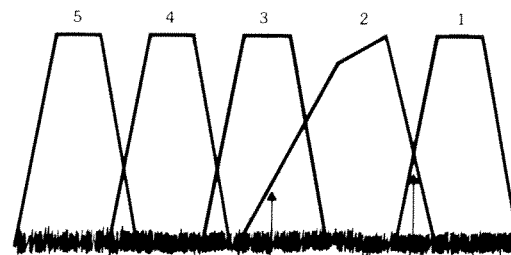

Adjacent Channel Crosstalk from Poor Filter Selectivity.

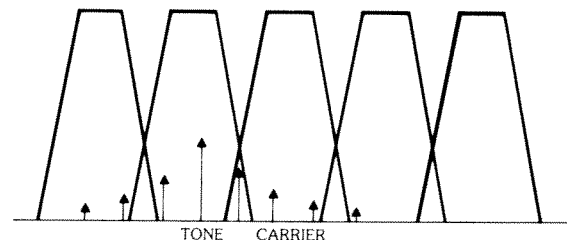

Intermodulation Crosstalk in Adjacent Channels

The precise procedure used for crosstalk depends on the type of crosstalk being measured. The convenience features and excellent filter selectivity of the 3586A/B SLM combined with the high signal purity and accuracy of the 3336A/B Synthesizer/Level Generator make an ideal combination for crosstalk measurements.

Crosstalk measurement guidelines:

- Use **OFFSET** to make measurements referenced to test tone level or TLP.
- Use **FREQ STEP** to step to desired measurement channel; or alternatively **STORE** various test channel frequencies in the nine available storage registers and **RECALL** as desired.
- Identify crosstalk signals in the test channel with the frequency counter
- Use the 20 Hz bandwidth to isolate the crosstalk test signal from other possible close-by signals.

¹Freeman, Roger L., Telecommunication Transmission Handbook, 1975, John Wiley & Sons, Inc.

²Members of the Technical Staff, Bell Telephone Laboratory, Transmission Systems for Communications, Western Electric Company, Inc. 1971

3336A, B & C Synthesizer/Level Generator

Basic Operation

Operation of the HP 3336A,B,C is quite straight forward. This section is intended to help you take full advantage of its versatility and capability. A quick reference summary of features is shown on pages 8 and 9.

Frequency Range of Outputs

The overall frequency range of the 3336A, B & C is 10 Hz to 20.999 999 999 MHz; however, only the 50Ω or 75Ω outputs are specified over this range.

The 124Ω, 135Ω, 150Ω and 600Ω balanced outputs are fully specified over frequency ranges normally required by equipment specifications. Any impedance output can be used over the full 10 Hz to 20.9 MHz frequency range with reduced performance outside the specified range. The 600Ω output performance is probably not useful above 1 MHz.

The frequency range for each output is actually somewhat higher when the full resolution is included as shown below:

Output	Frequency Range
50Ω, 75Ω	10 Hz to 20.999 999 999 MHz
124Ω	10kHz to 10.999 999 999 MHz
135Ω, 150Ω	10kHz to 2.099 999 999 MHz
600Ω	200 Hz to 109.999 999 999 kHz

Frequency Resolution

Frequency resolution is 1 microhertz (.000001 Hz) up to 99.999 999 999 kHz and 1 millihertz (.001 Hz) from 100.000 000 kHz and above.

Data Entry

Frequency, amplitude and phase offset can be entered by pressing the chosen ENTRY key, the numeric keys and then the entry suffix (MHz, dBm, degrees, etc.).

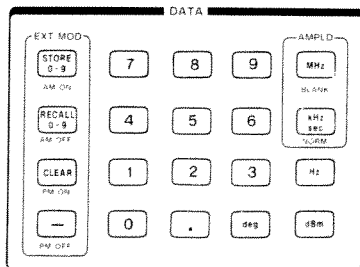

For example, a -10 dBm, 20 MHz signal is entered as follows:

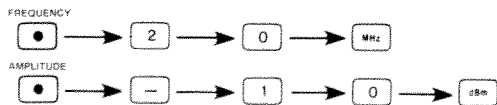

If an entry error is made, "ERROR" is displayed and the previous operating state is retained. As long as the same entry (frequency, amplitude, etc.) is retained, numeric and suffix entries can be continuously made without again selecting the entry parameter. If a frequency outside the specified frequency range of an output is chosen, "F LIMIT ERROR" is momentarily displayed as a warning but the entry will be accepted.

Amplitude Range, Resolution

Amplitude resolution is always .01 dB over the ranges shown:

Output	Amplitude Range
50Ω	-71.23 to +8.76 dBm
75Ω, 600Ω	-72.99 to +1.00 dBm
124, 135, 150Ω	-78.23 to +1.76 dBm

Using Modify to Tune Signal Parameters

The MODIFY key and analog tuning control is a convenient means for tuning any one of seven signal or sweep parameters being displayed. The parameters are:

FREQUENCY	SWEEP START FREQUENCY
AMPLITUDE	SWEEP STOP FREQUENCY
PHASE	SWEEP TIME
	SWEEP MARKER

The modification is "real time," that is, any changes entered will immediately modify the signal output. Here's how it works. You simply select the digit you want to modify with these keys . The digit selected will flash brightly. The analog tuning control will increment the digit up or down with automatic carry-over.

Using the 3336A, B or C as a Sweeper

The sweep capability of the HP 3336 is one of its outstanding features. You can sweep logarithmically and linearly over the full frequency range of any waveform with synthesizer precision and $\pm .15$ dB leveling.

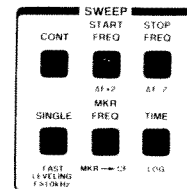

Not only is the sweep fully synthesized, but it is phase continuous over the full range. This means that it sweeps like a VCO without the phase discontinuities commonly found with sweeping or stepping synthesizers. This is an important feature when testing phase lock loops or other phase responsive devices.

Sweep time can be set from .01 to 99.9 seconds, depending on the parameters chosen as shown below:

Sweep Time Range	Sweep Parameter
.01 - 99.99 sec.	Linear
.1 - 99.99 sec.	Continuous Log
2 - 99.99 sec.	Single Log

Internally Leveled Output

The output level of the HP 3336A is internally leveled to $\pm .15$ dB in the NORMAL LEVELING mode for a .5 second sweep time, and in the FAST LEVELING mode for a .03 second sweep time. The NORMAL LEVELING mode is normally used for the lower frequency range of 50 Hz to 1 MHz where a slower loop response time is required. The FAST LEVELING mode is used for the 10 kHz to 20 MHz frequency range. Note that using the LEVELING modes in the incorrect frequency range will result in degraded output level accuracy, flatness and distortion.

To change from one leveling mode to the other, press the BLUE shift key followed by fast leveling.

External Amplitude Leveling

An external amplitude leveling input (located on the rear panel) allows regulation of the amplitude at a remote point. This input, marked EXT LEVEL, has a nominal input impedance of 1 kilohm. A ± 1 volt change at this input causes a $\pm .25$ dB change in the output.

Sweep Marker

The HP 3336A also includes a sweep marker. Unlike some sweepers which provide a marker birdie superimposed on the main signal output, the 3336 provides a negative going TTL transition signal on a separate rear panel output. The position of the marker on a swept display can be chosen anywhere between the sweep end points by defining the marker frequency with the MKR FREQ key. A swept passband filter with the marker connected to a second channel is shown in Figure

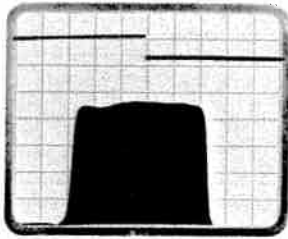

Passband Filter Response with Marker

Using the Storage Registers

The HP 3336A has ten storage registers, 0 through 9, that are accessible from the front panel DATA group, another time-saving feature.

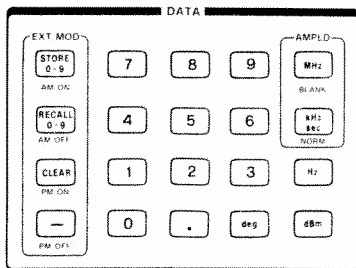

Any combination of front panel parameters except phase offset can be stored by pressing **STORE** and then a numeric of 0 or any number up to 9. When needed, the parameter set can be recalled by pressing **RECALL** and the register number. The parameters stored in that register (except phase) will maintain their integrity unless a new parameter set is stored into the register or the power is turned off. This feature is particularly useful when a number of repetitive tests need to be made.

Operating the Phase Control

The PHASE key allows selection of up to 719.9 degrees of absolute phase offset. When phase offset has been implemented, the phase of the main output signal (any waveform) will have been advanced or retarded depending on the polarity of the specified offset.

Here is how it works. Simply press the PHASE key followed by the numerical entry and then terminate the sequence with the DEG key. An immediate change in phase at the output will be initiated. For example:



will cause the output phase to advance 90 degrees. The modify function can be used to continuously "tune" the phase.

A selected phase is relative to an initial output phase. A second phase selection of 10 degrees, for example, following the 90 degree offset, would return the signal phase to 10 degrees relative to the initial phase. ASGN ZERO 0 is a convenient feature for defining any phase offset previously selected as zero phase (the display is set to read zero degrees). Two keystrokes are all that is necessary to set your new phase reference.

See page 29 for more information on dual channel phase operation and phase locking instruments together.

External Amplitude and Phase Modulation

The HP 3336A can be amplitude modulated up to 100% from 50 Hz to 50 kHz. The output can also be phase modulated to a depth of $\pm 850^\circ$ from dc to 5 kHz. Both AM and PM can be applied simultaneously and both require a modulation amplitude of ± 5 Vdc for full modulation depth.

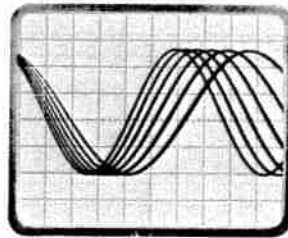
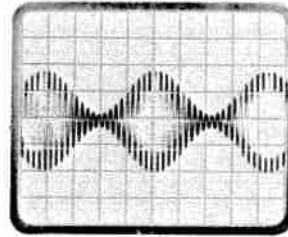

AM is activated by pressing the blue prefix key and the **STORE** key and turned off with the blue prefix key and the **RECALL** keys. The same sequence with the **CLEAR** and **-** keys control the PM. Whenever a modulation control key is pressed, the display momentarily indicates the ON, OFF state of both AM and PM.

Sync Output

A rear panel SYNC OUT connector provides a squarewave output at a frequency identical to the main output with an amplitude of $> 1.2V_{high} < 0.2V_{low}$ into 50 Ω . The squarewave lags the main output crossover by approximately 25 ns and the output impedance is 50 Ω .

Rear Panel Outputs



21 - 61 MHz Auxiliary Output

This output provides an ac coupled squarewave at a fixed level of nominally 0 dBm over the frequency range of 21.000 000 MHz to 60.999 999 MHz with under-ranging down to 20.000 000 001 MHz. The signal output automatically switches to the AUX output whenever frequencies greater than 20.999 999 999 MHz are entered. The front panel "21 - 60 MHz REAR" annunciator indicates that the AUX output is active. Once the AUX output has been activated, frequencies as low as 20.000 001 MHz can be entered. The output will automatically switch back to the main output when a frequency of 20 MHz or lower is entered.

While this output retains the accuracy, stability, phase noise and resolution of the main output, the harmonics are down typically 10 dB, the output amplitude cannot be changed, nor can the frequency be swept.

X-Axis Drive

This output provides a 0 to 10 V ramp proportional to the sweep frequency for any span width entered. The linearity of the range is < 0.1%, and the ramp is always positive with $f_{start} = 0$ V and $f_{stop} = 10$ V. However, f_{start} can be higher than f_{stop} for linear sweeps.

Sweep Marker Output

This output provides a TTL compatible voltage transition at the keyboard selected marker frequency for linear sweep only. See below for ways to use this output for sweeper applications.

Z-Blank Output

The Z BLANK output voltages are TTL compatible, and the output logic levels are as follows:

Linear Sweep:

Single: Goes LOW at start of sweep, HIGH at stop, whether the sweep is up or down. Remains HIGH until start of next sweep. Continuous: LOW during sweep up, HIGH during sweep down.

Log Sweep:

Goes LOW at start frequency, HIGH at stop. In single sweep, remains HIGH until start of next sweep. In continuous sweep, is HIGH momentarily at stop frequency.

When the Z BLANK output is low, it is capable of sinking current through a relay or other device. The maximum ratings are:

Maximum current sink: 200 mA

Allowable voltage range: 0 V to +45 Vdc

Maximum power (voltage at output x currents): 1 W

Reference Outputs

The 1 MHz reference provides a nominal 0 dBm squarewave output to phase lock other instruments to the 3336A.

The 10 MHz oven output provides a nominal 0 dBm output from the high stability frequency reference oscillator in Option 004 instruments only. This output is connected to the reference input.

External Reference Input

The HP 3336A may be operated with an external reference to control the standard 30 MHz internal reference oscillator frequency. The external reference level must be greater than 0 dBm (50 ohms), and the frequency must be within 1% of 10 MHz or a sub-multiple thereof, down to 1 MHz (10, 5, 3.33, 2.5 or 1 MHz). The front panel EXT REF annunciator will light to indicate that an external reference is being used. The internal reference oscillator is phase locked to the external reference, and a phase lock detector circuit causes the EXT REF light to flash if synchronization is lost.

Options

Option 001

3336A – 75Ω 1.6/5.6 mm metric connector replaces the standard BNC.

3336B – 75Ω mates with WECO 358A and 124Ω mates with WECO 372A, ("LARGE WECO").

Option 001 should be ordered with the instrument, or retrofitted at the factory for an additional charge.

Option 004

3336A/B/C High Stability Frequency Reference

Option 001 is a temperature controlled 10 MHz oscillator which provides increased frequency stability over the standard instrument. The aging rate is 5×10^{-8} per week or 1×10^{-7} per month and the accuracy is increased to 5×10^{-8} over 0° to 50°C . The oven will remain on as long as ac power is connected to the instrument, whether the power switch is on or off. The reference will be within $\pm 1 \times 10^{-7}$ of final value 15 minutes after turn-on at 25°C if the oven has been off less than 24 hours.

This option can be easily retrofitted into standard instruments. An installation kit, HP P/N 11477A, is available.

Option 005

3336A/B/C Precision Attenuator

This option significantly improves the level accuracy, flatness and spurious level of the 3336A, B or C (see the Specification Summary, page 10). Option 005 should be ordered with the instrument, or retrofitted at the factory (additional charge).

Precision Attenuator Accuracy

Attenuator Range	Accuracy
10 to 19.99 dB	$\pm .035$ dB
20 to 29.99 dB	$\pm .06$ dB
40 to 79.99 dB	$\pm .1$ dB

Applications

See the 3586A, B & C Basic Measurements Mode Section, page 11 for 3336A, B & C frequency tracking applications with the 3586A, B & C Selective Level Meter.

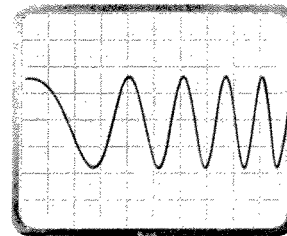

Wideband Sweep

The HP 3336A provides excellent wideband, leveled sweeping capability in addition to its performance as a synthesizer and function generator. Because of the single phase lock loop fractional-N design, the sweep is entirely phase continuous and the frequency can be swept over the full range of each waveform with sweep times from .01 to 99.9 seconds per sweep. Since the 3336A is a synthesizer, very narrow frequency bands can be swept, less than .2 MHz for fast sweep times and less than 1 Hz for slower sweep times. The minimum linear sweep width is $.2 \text{ na/sec} \times (\text{sweep time}) \text{ sec}$.

The sweep in the linear continuous mode is from the start to stop frequency and back. The start frequency can be higher than the stop frequency. When used with a plotter or oscilloscope swept display, the Z-blank output blanks the retrace. Log sweep and single sweep are from start to stop only, with no return sweep.

The log sweep ramp is a piece-wise linear approximation of a two-piece approximation per decade as shown. The single sweep range is a ten-piece approximation. The more accurate approximation in log single sweep is necessary for accurate swept presentations on a plotter. It is important to note that log sweeps can be made in decade multiples only. If a start-stop entry other than a decade multiple is made, the sweep will stop at the last decade multiple stop frequency within the sweep width.

Another important point to remember is that the actual stop frequency in log sweep will be slightly higher than the programmed stop frequency by no more than 1/4% as a result of the approximation calculation. The hesitations noted in log sweep occur while the microprocessor is calculating the next approximation.

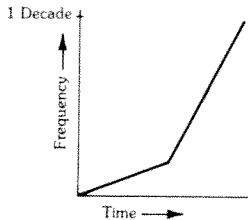

Two-Piece Log Ramp Approximation, Continuous Sweep

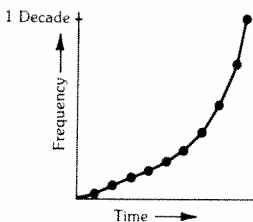

Ten-Piece Log Ramp Approximation, Single Sweep

Swept Frequency Response of Networks

The block diagram shows a typical test set-up for displaying a swept response on an oscilloscope.

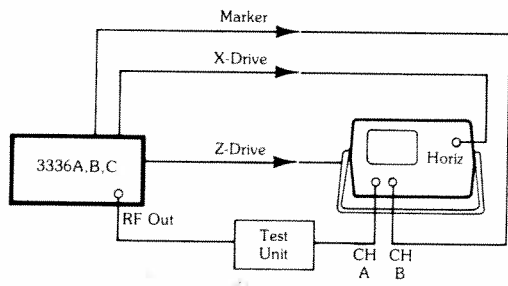

Swept Response Test Set-Up

A typical filter response display including the frequency marker is shown. The vertical position has been set so that only the positive peaks of the waveform as shaped by the filter are shown. This filter has a center frequency of 7.98 MHz and a bandwidth of 8 kHz. The display was achieved by using the convenient marker and zoom ($\Delta F \times 2$, $\Delta F + 2$) functions.

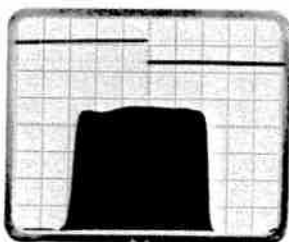

Typical Filter Response with Marker

The START and STOP frequencies are set to encompass the passband, 7 to 10 MHz for the example shown. The marker can be set to the passband frequency with the MODIFY function and the passband moved to the center of the display with MKR → CF (marker to center frequency). Successively using $\Delta F + 2$ reduces the span to obtain the desired response.

Obtaining Desired Swept Response

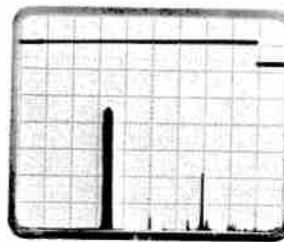

a. 7-10 MHz Sweep

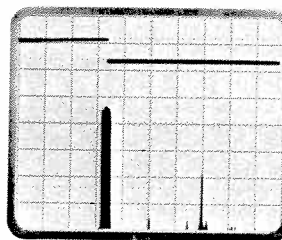

b. Marker to Response with Modify

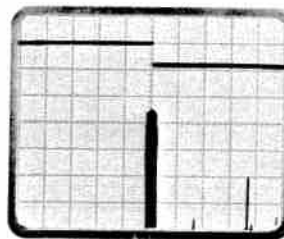

c. MKR → CF

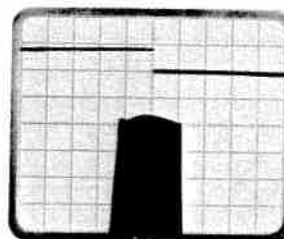

d. $\Delta F + 2$

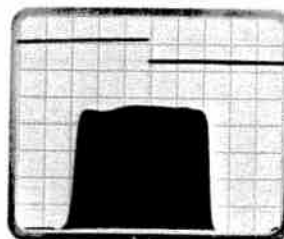

e. $\Delta F + 2$

Sweep Time Too Fast

Note that if the sweep time is too fast (.01s in this case), the display will be distorted as shown. This happens when the fast sweep time causes rapid amplitude changes that are faster than the settling time of the filter. This is especially true with very narrow filters. To set the sweep time to the proper value, start with a very slow time and increase it until distortion is evident and then reduce it to an acceptable value.

Sweep Time is Set Too Fast for Filter to Settle

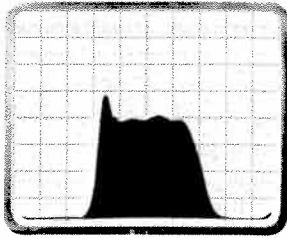

Other Considerations

The accuracy of swept response measurements can be adversely affected by other factors such as:

Fast or slow leveling incorrectly chosen impedance mismatches between source or display and the unit under test. Matching networks, pads and terminations must be used so that the instruments used as well as the unit tested are properly terminated.

Excessive amplitude causing saturation of active devices such as amplifiers.

Swept Measurements Using the 3575A Gain/Phase Meter

The 3575A Gain/Phase Meter is an excellent detector to use with the 3336 in the swept mode since it can provide log amplitude as well as phase information from 1 Hz to 13 MHz.

The test set-up shown below is configured to measure the amplitude characteristics of a 1.0073 MHz crystal and record the display on an HP 7004B X-Y Plotter. In this case, the sweep time must be very slow, 99 s, because of the slow settling time of the narrowband high-Q crystal. Plotter response time is also considerably more limited than that of the oscilloscope. The sweep width is 4 kHz.

A log frequency plot of a 10 kHz low pass filter is shown with a sweep span of 1 kHz to 1 MHz and a sweep time of 99s. Single sweep is used, providing a more accurate log ramp.

Care must be taken when making log plots to make sure that the sweep rate is not excessive. This can be more of a problem with log plots because the sweep rate (Hz per second) increases as the sweep progresses. Thus, distortion problems due to settling time would most likely occur at the high frequency end of the sweep, rather than at the low end.

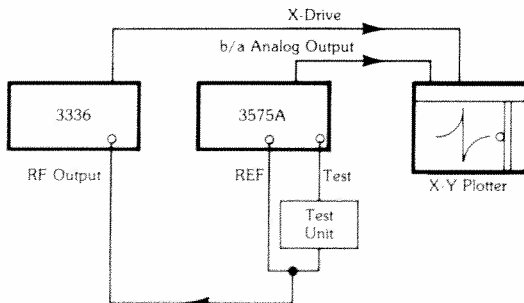

Amplitude and phase measurements with the HP 3575A Gain/Phase Meter.

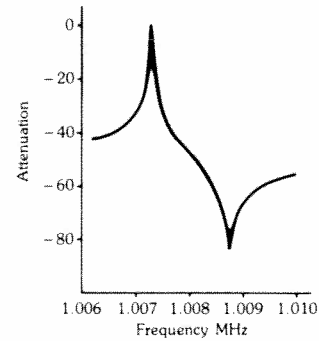

Amplitude response of 1.0073 MHz crystal.

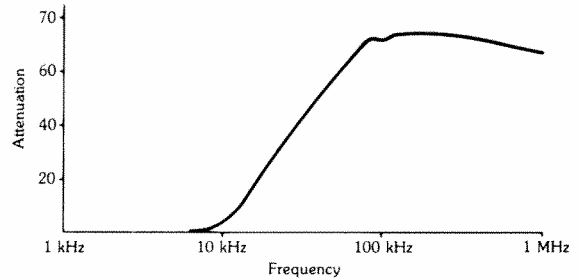

Log frequency swept response of 10 kHz Low Pass Filter.

Phase, Dual Phase and Synchronizing Phase Offset

The phase can be changed with 0.2° increment accuracy and $.1^\circ$ resolution with respect to an arbitrary starting phase, or an assigned zero reference. The phase range is $\pm 719.9^\circ$. The modify function can be used to continuously step the phase in 0.1° increments.

Dual Phase Operation

Two Hp 3336 instruments can be synchronized or phase locked together as shown, providing two phase variable outputs.

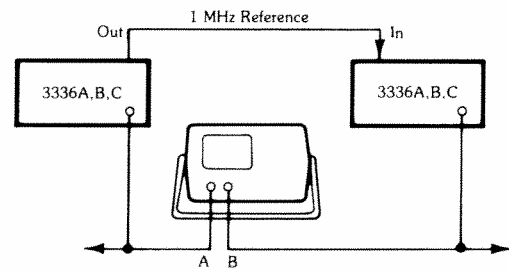

Dual Phase Test Set-Up

At turn-on, both instruments are phase locked together, but are not at the same phase. They can be synchronized in phase by connecting both outputs to a dual channel oscilloscope or phase meter as shown and changing the phase of one with respect to the other until they are synchronized. The MODIFY function is convenient to use for this purpose.

Once synchronized, both phase registers can be assigned zero phase and then either output can be changed with respect to each other, or the zero reference.

Synchronizing Other Instruments

The 3336 can be used as a phase lock reference to another instrument or a stable reference can be used to synchronize the HP 3336A, B or C.

Reference Output

The 1 MHz reference output is a 1 MHz squarewave at nominally 0 dBm output. Option 004 instruments also have a 10 MHz stable reference which can be used for synchronizing to other instruments. However, this reference must also be connected to the 3336 reference input. A number of instruments may be locked in parallel as long as enough amplitude is available for each instrument.

Reference Input

The reference input will accept 1 or 10 MHz or any sub-harmonic of 10 MHz (2.5, 3.33, 5 MHz, etc.) for synchronizing the 3336. The frequency must be within 1% of 10 MHz, or 1% N, if a sub-harmonic is used.

The typical amplitude locking range is from 0 dBm to +20 dBm. The front panel REF annunciator light is on when this input is used and it blinks if lock is lost.

Linearity Testing of VCO's

The sweeping capability of the 3336 combined with an X-drive output linearity of better than .1% can be used for rapid VCO linearity measurements. The measurement is made by connecting the VCO under test to a phase lock loop and using the 3336 as a linear ramp source with a tracking frequency output as shown. As the ramp (X-drive output) tunes the VCO, the output frequency is compared to the tracking 3336 output in a phase detector (double balanced mixer). The error voltage output is directly proportional to the non-linearity of the VCO compared to the 3336.

The error voltage can be plotted on an X-Y plotter for precise measurements or continuously displayed on an oscilloscope for calibration and adjustment.

Any VCO can be tested whose direct or divided frequency is within the 10 Hz to 20.9 MHz frequency range of the 3336A, B or C.

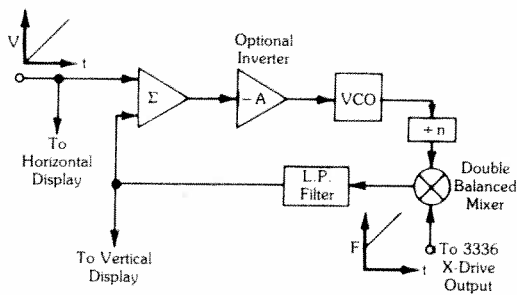

VCO Under Test Connected in Phase-locked Loop

The Loop Design

A typical VCO from 3336 RF output under test is illustrated below. In this example, the tune input of the VCO requires that the positive sweep output of the 3336 be inverted and offset. This inversion is provided by the operational amplifier. Since the proper polarity of the VCO tune input is obtained from the output of the operational amplifier, the optional inverter is not required. The ratio R_1 to R_2 scales the sweep while R_{0a} adjusts the offset. Since the 8 to 12 MHz output of the VCO is in the frequency range of the 3336, no divider is necessary.

To insure proper operation of the phase-locked loop, several guidelines should be followed. The ratio of R_1 to R_2 sets the loop gain or pull range so that the loop remains locked over the entire sweep range. The network consisting of R_5 and C_5 may be needed to stabilize the loop. Selection of these components is unique to each loop design. The cutoff frequency of the 4-pole low pass filter should be less than one-fourth of the lowest output fre-

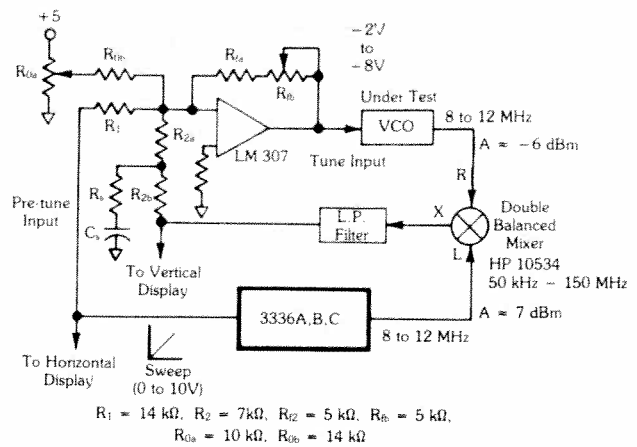

Phase-locked Loop Design for Testing VCO

quency of the VCO. An oscilloscope trace of the error voltage of the network is shown below.

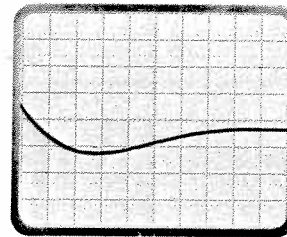

An Oscilloscope Display of Error Voltage

The error curve calibration factor CF in terms of Hz per volt for the display may be determined as:

$$CF = \frac{R_1}{R_2} \frac{F_{\text{tune range}}}{V_{\text{pre-tune range}}} \text{ Hz/Volt}$$

For the example above, where $F_{\text{tune range}} = 4 \text{ MHz}$, $V_{\text{pre-tune range}} = 10.00 \text{ V}$, $R_1 = 14 \text{ k}$, and $R_2 = 7 \text{ k}$, CF is 800 kHz/volt. For the display shown, the vertical sensitivity of the oscilloscope was set to 0.05 volts/division. Therefore, the CF for this display is 40 kHz/division (.05 V/division x 800 kHz/V = 40 kHz/division). The non-linearity error in the voltage-to-frequency transfer of the VCO may be easily determined at any frequency. At 8.8 MHz, for example, the output frequency is approximately 50 kHz low. This represents an error of 1.2% of the 4 MHz sweep range.

Improper selection of offset, tune range, or loop gain may allow the loop to drop out of lock over part of the sweep range. The display below illustrates the results of an improperly adjusted loop.

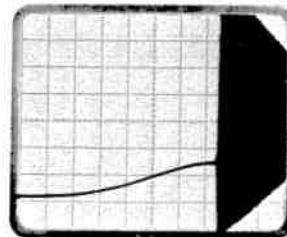

An Oscilloscope Display of Error Voltage for an Improperly Adjusted Phase-locked Loop

Phase Lock Loop Testing

Closed loop testing of frequency response up to 10 kHz and transient response of phase lock loops (PLL's) is made possible by the phase modulation capability of the 3336. A number of techniques can be used for these measurements; these two have been chosen for their simplicity.

For more information on these two techniques and other phase lock loop measurements, see HP Application Note AN164-3, "New Techniques for Analyzing Phase Lock Loops."

Closed Loop Frequency Response, Using an RF Spectrum Analyzer

This method of obtaining frequency response is extremely useful because few instruments are required and the test set-up is extremely simple (figure below). This method can be used to test loop frequency response at rates up to 10 kHz and is limited at low frequencies only by the resolution of the spectrum analyzer. In order to test loop frequency response above 5 kHz, it is necessary to calibrate the phase modulation rate response between 5 kHz and 10 kHz. The response is typically 6 dB down at 10 kHz.

Operation

In this set-up, the 3336 is phase modulated using a test oscillator, a second 3336 and the PLL frequency response is displayed by the level of the first sideband as the modulation rate is varied.

This technique is possible because in phase modulation the level of the sidebands is independent of the modulation rate. Also for small modulation deviations (i.e., less than 30°), the amplitude of the first sideband is almost directly proportional to the phase deviation. Thus the first sideband amplitude essentially tracks the closed loop frequency response.

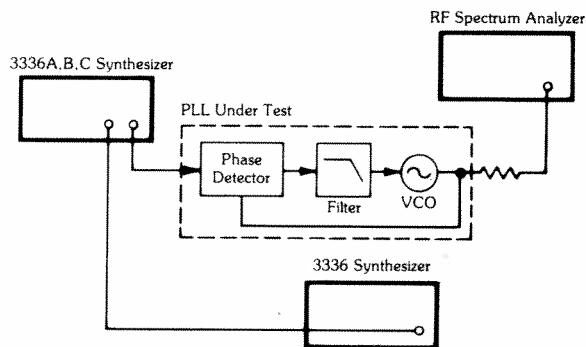

PPL Analysis Set-up Using an RF Spectrum Analyzer

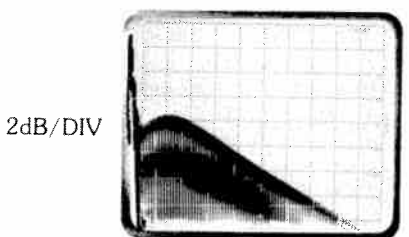

PLL Frequency Response

Measurement Procedure

- With the 3336 phase modulation on and adjusted for a deviation of less than 30° , adjust the spectrum analyzer to the appropriate scan width and resolution. Tune the analyzer such that the carrier is on the left edge of the display.

Since the first sideband carries the frequency response information, adjust the spectrum analyzer's IF attenuation so that this sideband is conveniently positioned vertically on the display.

- If the spectrum analyzer has variable persistence, turn it to maximum and slowly sweep the frequency of the second 3336. The resulting display is the PLL frequency response.

Closed Loop Transient Response

In many applications it is desirable to measure a phase lock loop's response to transients in order to determine such parameters as rise time, overshoot, damping factor, etc. The test set-up shown (figure below) can be used to obtain PLL response for step changes in phase. With calibrated phase modulation the size of the phase, steps can accurately be controlled to ensure operation in the linear region of the PLL under test and of phase detector #2.

Operation

In this test set-up, 3336 #1 is phase modulated with a squarewave which causes the RF output to switch back and forth between two discrete phases. The VCO output is then demodulated and the resulting response to step changes in phase is displayed on the oscilloscope.

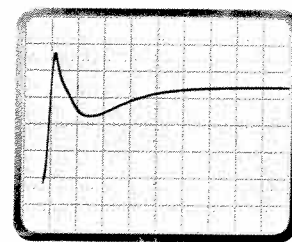
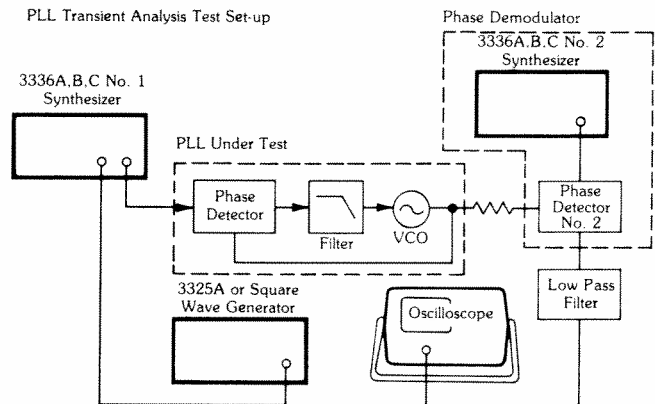

PLL Response to Step Changes in Phase.

Measurement Procedure

- Connect the equipment as shown (figure above). Connect both 3336's to the same frequency standard so that they are frequency coherent.
- With the modulation off, step 3336 #2 up and back down 1 or 2 Hz until phase detector #2 is operating in the center of its range.
- Turn on 3336 #1 phase modulation. Set the phase deviation small enough to ensure linear operation of the PLL and phase detector #2. Then observe the PLL transient response on the oscilloscope.

Chapter V

Remote Control

Introduction

3586A, B & C Selective Level Meter (SLM) 3336A, B & C Synthesizer/Level Generator (SLG)

Both instruments can be operated remotely on the Hewlett-Packard Interface Bus (HP-IB*), using a desktop computer controller such as the HP9825A, 9835A, 9845A/B, or mainframe computer such as the HP 1000 series.

Instrument operation can be automated either singly or integrated with two or more instruments to form a system. The 3586 Selective Level Meter and 3336 Synthesizer/Level Generator are often operated from a controller as a measurement set or with additional instruments such as printers or plotters for data manipulation and output of permanent records. Both instruments can be interrogated to output measurement data or instrument status.

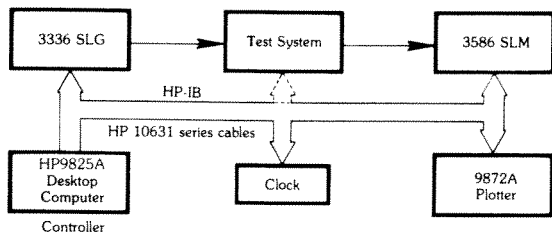

Typical Automated Test System

HP-IB Extender

Up to 14 instruments may be operated from a single controller with up to 20 meter separation if HP 10631 series cables are used alone. Remote operation with up to 1000 meters separation is possible using the HP 37210A Bus Extender.

The addition of modems allows operation over telephone circuits to virtually any distance. This capability is of particular importance for surveillance of FDM systems where the controller, selective level meter and level generator may be separated by thousands of miles.

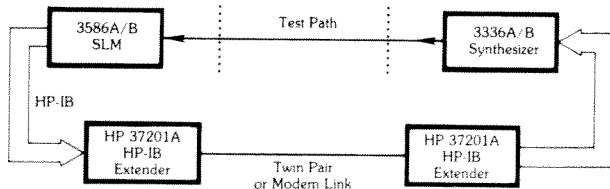

Remote Frequency Tracking

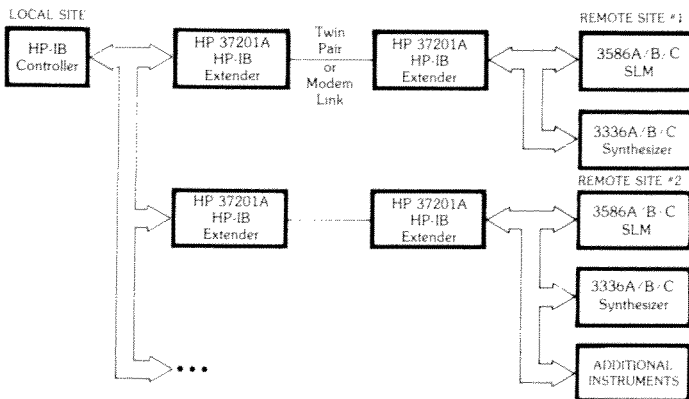

Remote Site Measurements with Controller

Remote Operation of the 3586A, B & C SLM

Instrument Programming Codes

All of the HP 3586 programming codes and their binary, octal, decimal and hexadecimal values are presented in Table I. Each programming code is an instruction to the instrument. In most cases, sending these instructions corresponds to pressing front panel controls during local operation. For instance, receiving the ASCII characters CH1 during Remote operation has the same effect as pressing **CH1** during local operation. There are exceptions to this one-to-one relationship. All of the "on/off" controls, the dB and volume controls, all controls in the Frequency Tune group and instrument functions not controllable from the front panel.

Formats for Programming

The format for instrument programming codes depends on the sophistication of the instrument function being controlled. A unique two or three ASCII character code is sent to the instrument to activate functions controlled by front panel keys in Local mode. For example, the instruction E1 programs the SELECTIVE tuning mode. While the characters comprising each code must be sent in a certain order, the codes themselves can be sent in any order within a group. Sending E1, T1, CH2 selects SELECTIVE tuning, the BRIDGED 75 Ohm Input and the upper sideband CHANNEL in that order. Sending CH2, T1, E1 will set the same instrument functions in reverse order. Note that the HP 3586 ignores commas. They are included in the data string examples for clarity.

When the HP 3586 is in the Local mode, certain instrument functions are set using several front panel controls. For instance, to enter the Entry Frequency, the **FREQ** control is pressed, the appropriate digits are entered and then **Hz**, **kHz** or **MHz** is pressed. This method is used because the Entry Frequency can assume so many different values that individual switches for each value are impractical. Obviously the order in which the controls are actuated is important. When operating in the Remote mode, almost the same method is used to set the Entry Frequency except that ASCII characters are sent over the HP-IB to activate the instrument functions instead of pressing front panel controls. The ASCII character group "FR" actuates the function controlled by **FREQ**, ASCII digits correspond to the digit controls and the functions controlled by **Hz**, **kHz** and **MHz** are actuated by the ASCII character groups "HZ," "KZ" and "MZ" respectively. For example, to enter an Entry Frequency of 250 kHz, the ASCII character group "FR,250,KZ" is sent. As before, the order within the group is important; however, this ASCII character group can be placed anywhere in a large group of instrument instructions. Observe that the groups E1,FR250KZ,T1 and FR250KZ,E1,T1 and T1,E1,FR250KZ all result in the same instrument settings. Other functions of the HP 3586 set by this method are Frequency Step, Full Scale, Offset, Threshold and Time.

HP 3586A, B & C Programming Codes

Instruction	ASCII Characters	Binary Code	Octal Code	Decimal Code	Hexadecimal Code		
MEASUREMENT							
Wideband	W	01010111	127	87			
Selective	B	01000010	102	66	42		
LOW DISTortion	M	01001101	115	77	4D		
	1	00110001	61	49	31		
LOW NOISE (3586C, see M2)	M	01001101	115	77	4D		
	6	00110110	66	54	36		
SSB Channel							
NOISE/DEMODulation (Low Noise, 3586C only)	M	01001101	115	77	4D		
	2	00110010	62	50	32		
1010Hz, TONE 1004Hz	M	01001101	115	77	4D		
	3	00110011	63	51	33		
CARRIER							
	M	01001101	115	77	4D		
	4	00110100	64	52	34		
TONE 800Hz, 2600Hz	M	01001101	115	77	4D		
	5	00110101	65	53	35		
JITTER	M	01001101	115	77	4D		
	7	00110111	67	55	37		
NOISE/TONE	M	01001101	115	77	4D		
	8	00111000	70	56	38		
IMPULSE	M	01001101	115	77	4D		
	9	00111001	71	57	39		
Impulse START	S	01010011	123	83	53		
	I	01001001	111	73	49		
MEASUREMENT/ENTRY							
Range							
10dB	R	01010010	122	82	52		
	1	00110001	61	49	31		
100dB	R	01010010	122	82	52		
	2	00110010	62	50	32		
Full Scale							
AUTOMATIC	F	01000110	106	70	46		
	1	00110001	61	49	31		
ENTRY	F	01000110	106	70	46		
	2	00110010	62	50	32		
AVERAGE Off	A	01000001	101	65	41		
	0	00110000	60	48	30		
AVERAGE On	A	01000001	101	65	41		
	1	00110001	61	49	31		
UNIT							
dBm	U	01010101	125	85	55		
	1	00110001	61	49	31		
dBpw (dBV 1V, 3586C)	U	01010101	125	85	55		
	2	00110010	62	50	32		
dB .775V	U	01010101	125	85	55		
	3	00110011	63	51	33		
OFFSET Off	O	01001111	117	79	4F		
	S	01010011	123	83	53		
	0	00110000	60	48	30		
OFFSET On	O	01001111	117	79	4F		
	S	01010011	123	83	53		
	1	00110001	61	49	31		
TERMINATION							
A	B	C					
10k 50pf(750)	10k 50pf(750)	500	T	01010100	124	84	54
			1	00110001	61	49	31
750	750	750	T	01010100	124	84	54
			2	00110010	62	50	32
1500	1240	10k 50pf(500)	T	01010100	124	84	54
			3	00110011	63	51	33
	1350	10k 50pf(750)	T	01010100	124	84	54
			4	00110100	64	52	34
Bridged-6000	Bridged-6000	Bridged-6000	T	01010100	124	84	54
			5	00110101	65	53	35
6000	6000	6000	T	01010100	124	84	54
			6	00110110	66	54	36
FREQUENCY/ENTRY							
Entry Frequency							
SSB CARRIER	E	01000101	105	69	45		
	1	00110001	61	49	31		
SSB TONE	E	01000101	105	69	45		
	2	00110010	62	50	32		
Channel							
(LSB)	C	01000011	103	67	43		
	H	01001000	110	72	48		
	1	00110001	61	49	31		
(USB)	C	01000011	103	67	43		
	H	01001000	110	72	48		
	2	00110010	62	50	32		
COUNTER Off	C	01000011	103	67	43		
	N	01001110	116	78	4E		
	0	00110000	60	48	30		
COUNTER On	C	01000011	103	67	43		
	N	01001110	116	78	4E		
	1	00110001	61	49	31		

TABLE I

HP 3586A, B & C Programming Codes

Instruction	ASCII Characters	Binary Code	Octal Code	Decimal Code	Hexadecimal Code
ENTRY					
FREQuency	F	01000110	106	70	46
	R	01010010	122	82	52
FREQuency STEP	S	01010011	123	83	53
	P	01010000	120	80	50
FULL SCALE	F	01000110	106	70	46
	S	01010011	123	83	53
OFFSET	O	01001111	117	79	4F
	F	01000110	106	70	46
STORE	S	01010011	123	83	53
	T	01010100	124	84	54
RECALL	R	01010010	122	82	52
	C	01000011	103	67	43
TRESH (Threshold)	T	01010100	124	84	54
	H	01001000	110	72	48
TIME	T	01010100	124	84	54
	I	01001001	111	73	49
0	Ø	00110000	60	48	30
1	1	00110001	61	49	31
2	2	00110010	62	50	32
3	3	00110011	63	51	33
4	4	00110100	64	52	34
5	5	00110101	65	53	35
6	6	00110110	66	54	36
7	7	00110111	67	55	37
8	8	00111000	70	56	38
9	9	00111001	71	57	39
. (decimal)	.	00111100	74	60	3C
!	U	01010101	125	85	55
	P	01010000	120	80	56
!	P	01000100	104	68	44
	N	01001110	116	78	4E
Hz	H	01001000	110	72	48
kHz	z	01011010	132	90	5A
	k	01001011	113	75	4B
or	H	01001000	110	72	48
	k	01001011	113	75	4B
MHz	z	01011010	132	90	5A
	M	01001101	115	77	4D
or	H	01001000	110	72	48
	M	01001101	115	77	4D
dB	z	01011010	132	90	5A
	D	01000100	104	68	44
MEASure CONTinue	B	01000010	102	66	42
	M	01001101	115	77	4D
RDNG--OFFSET (Reading--Offset)	C	01000011	103	67	43
	R	01010010	122	82	52
CNTR--FREQuency (Counter--Frequency)	O	01001111	117	79	4F
	C	01000011	103	67	43
BANDWIDTH	F	01000110	106	70	46
	B	01000010	102	66	42
2000 1740 3100	1	00110001	61	49	31
	B	01000010	102	66	42
400Hz	2	00110010	62	50	32
20Hz	B	01000010	102	66	42
	3	00110011	63	51	33
WTD (Weighted)	B	01000010	102	66	42
	4	00110100	64	52	34
AUDIO					
VOLUME Off	V	01010110	126	86	56
	Ø	00110000	60	48	30
VOLUME On	V	01010110	126	86	56
	1	00110001	61	49	31
MISCELLANEOUS					
Interograte	I	01001001	111	73	49
	N	01001110	116	78	4E
CALibrate Off	C	01000011	103	67	43
	A	01000001	101	65	41
	Ø	00110000	60	48	30
CALibrate On	C	01000011	103	67	43
	A	01000001	101	65	41
	1	00110001	61	49	31
Fast Calibrate	C	01000011	103	67	43
	L	01001100	114	76	4C

TABLE I (continued)

Outputting Data

The Data Message is used to transfer the results of measurements, or the value of any entered parameter from the HP 3586 to another device on the HP-IB. Usually, the device receiving the data is the controller. Entered parameters are those instrument functions, such as Frequency and Threshold, that are set by entering numerical values. The instructions sent to the instrument before it is instructed to send data determine which type of data will be transferred. If a measure instruction is sent, measurement data will be transferred. Likewise, if an interrogate instruction is sent, the value of the entry parameter designated in the instruction will be sent.

Measure Instructions

The results of each measurement can be transferred from the HP 3586 only once. A measure instruction must be sent to the instrument before each measurement data transfer to make new data available. There are two instructions that will trigger a measurement in the HP 3586. One is the Trigger Message. It should be used only when simultaneous response from the HP 3586A and another device on the bus is required. The other measure instruction is the programming code TR. This instruction actually directs the instrument to wait and then measure. The duration of the time delay depends on the bandwidth selection. The delay is inserted to allow time for the IF amplifiers in the instrument to adjust to any new signal conditions that might have been programmed. The ASCII instruction is sent to the HP 3586 using the Data Message just like other instructions actuating instrument functions. It can be included in a group of instructions as long as it is the last instruction in the group. It must be the last instruction so that all of the instrument functions can stabilize during the time delay.

If the signal being measured is not within the dynamic range of both the Input Amplifier and the IF Amplifiers, the measurement data will not have the normal instrument accuracy. Likewise, the frequency measurement is invalid when the counter is not locked to the input signal. When any of these conditions occur, it is indicated in the measurement data output string.

Interrogate

The value of any Entry parameter can be output over the HP-IB. This is useful whenever a routine in the program does a search that involves an entry parameter. For example, consider a routine that finds the threshold level that permits ten impulse counts per minute. The threshold is varied using the ↑↓ functions until the desired level is found. Once the desired level is found, the threshold is read using the interrogate instruction. Normally, the HP 3586 will output measurement data when it is addressed to talk. If Entry parameters are to be output, the instrument must be instructed to send the value of the selected parameter in place of the measurement data. This is done by sending an "interrogate" instruction to the instrument. An interrogate instruction consists of the ASCII characters IN followed by the ASCII instruction for the prefix of the selected parameter. For example, to interrogate the Frequency Step, the ASCII character group INSP is sent. The interrogate instruction is sent using the Data message like all other programming instructions. It can be sent in a group of instructions as long as a measure instruction does not follow it in the group. If a measure instruction follows an interrogate instruction, the interrogate instruction is negated. Once the parameter has been interrogated, its value will appear in the appropriate display until it is output. The selected Entry parameter will be output when the instrument is addressed to talk.

Calibration

The instrument automatically calibrates itself approximately every three minutes when it is in the Local mode and AUTOMATIC CALibration is on. During remote operation, the three minute calibration is disabled. This is done because

pseudo-random calibrations would make the execution time of the program statements unpredictable. If the instrument specifications are to be maintained every three minutes, the controller must direct the instrument to calibrate itself. Done this way, the calibration is predictable and cannot interrupt other programming statements.

Fast Calibration

When a Fast Calibration is executed, the instrument is only calibrated on its current range and in the widest bandwidth. This Calibration mode can be used in any of the Selective Measurement Modes. It was designed for use during automated surveillance of telecommunications systems.

Other Considerations

If possible, lock the instrument to the frequency reference of the signal source. This will simplify the tuning routine in the controller program. In an HP 3586 not equipped with Option 004 High Accuracy Frequency Reference, tuning errors of 200 Hz are possible at higher frequencies. When the 20 Hz bandwidth in one of these instruments is used, it is possible that the band-pass of the instrument will not include the Entry Frequency. This is not really a problem when the instrument is operated in a local mode, since the operator can quickly search for the signal and verify that the instrument is tuned to the proper signal using the Frequency controls. Locking the HP 3586A to the frequency reference of the signal source eliminates the need for a search and verify routine in the controller program. When this is done, the tuning procedure is reduced to simply programming the Entry Frequency. If it is not possible to lock the signal source and the HP 3586A together, use a high accuracy frequency reference. This will reduce the frequency error which, in turn, usually simplifies the required search and verify routine in the controller program.

Require Service

The Require Service Message is a request for service which is sent from a device on the HP-IB to the active controller. Any of the following conditions in the HP 3586A will generate a Require Service Message:

- Received an unrecognizable string
- Unable to calibrate
- Local oscillator not locked
- Tone not present for S/N or Phase Jitter Measurements
- Attempt to enter Full Scale level while in AUTO range

The Require Service Message is completely independent of all other bus activity. It is sent on a single line (wire) called the SRQ Line, whose state is either true or false. This line is shared by all devices on the HP-IB. When a Require Service Message is received, the controller must determine which device or devices are requesting service. It does this by conducting a Serial Poll. Each polled device responds by sending a Status Byte which indicates, among other things, whether or not the instrument requested service.

A Status Byte Message is sent by a device on the bus to the active controller. The individual bits of the Status Byte indicates the status of various device (instrument) functions and whether or not the instrument requested service. The definition of each bit in the HP 3586 Status Byte Message is presented in Table II. Once the Status Byte of an instrument is in the controller, the status of the instrument functions assigned to the bits can be determined by examining the truth state of each bit. The controller then takes appropriate action. For example, if bit 3 of the HP 3586 Status Byte is true, the controller might print a message advising the operator that a tone is required during S/N and Phase Jitter Measurements.

Bit True State Definition

0	Received unrecognizable string of ASCII characters.
1	Unable to calibrate.
2	Local oscillator unlocked.
3	Tone not present for S/N or Phase Jitter measurements.
4	Attempt to enter Full Scale level while in AUTOrange.
5	Reference not locked to external standard.
6	This instrument requested service.
7	Not used.

Table II True State Definitions of the Bits in the HP 3586 Status Byte.

Typical HPL Program

Programming the 3586A,B,C Selective Level Meter requires a working knowledge of the specific controller used. See the instruction manual for your particular controller. This section provides a typical program in HPL language (9825A) to illustrate remote operation. Specific measurement programs similar to those shown here can be used as sub-routines for more extensive test programs.

Both the HP9825A and HP9835A Desktop Computer require an HP Interface Card for HP-IB operation.

The HP-IB address setting for the instrument can be changed using the address switch on the rear panel. See page 7.

```

01: "3586A routine group measurements":
02: "19 July 78":
03:
04: dim D[0:100],T[0:100]
05: dev "3586A",716
06:
07: "group measurements":
08: cll 'group information'
09: cll 'group pilot measure'
10: cll 'group carrier leak measurement'
11: stp
12:
13:
14: "group information":
15: ent "freq plan BELL=0: CCITT=1",T[5]
16: ent "channel 1 carrier freq in khz=?",T[12]+T[12]*1e3+T[11]
17: ent "1= erect channels, -1=inverted channels",T[2]
18: ent "TLP in dbw=?",T[4]
19: ent "impedance? 75=0,135=1,124=2",T[3]
20:
21:
22: spc 5!prt "3586A,B PILOT-CARRIER LEAK TEST"i:spc 2
23: if T[3]=0!prt "Z= 75 ohms"
24: if T[3]=1!prt "Z= 135 ohms"
25: if T[3]=2!prt "Z= 124 ohms"
26: if T[2]=-1!prt "INVERTED CHANNEL"
27: if T[2]=1!prt "ERECT CHANNELS"
28: fnt "TLP= "f5.1"dbw"prt 16,T[4]
29: spc 3!fat
30: ret
31:
32: "group pilot measure":
33: dsp "group pilot measurements"
34: clr "3586A"prt "3586A","R1B1"
35: T[1]+T[2]*3.92e3-F!if T[5]=1!T[1]+T[2]*2.392e4+F
36: wrt "3586A","FR","F","HZ"
37: cll 'impedance write'(T[3])
38: wait 200
39: wrt "3586A","CN1"
40: cll '3586A amp freq read'(5,25,5,T[9],T[10])
41: wrt "3586A","CN0"
42: prt "GROUP PILOT"
43: spc 1!prt " dBm dBm0"i:spc 1
44: fnt 3x!f6.1,x!f6.1
45: fxd 2!prt 16,T[9],T[9]+T[4]
46: spc 1!prt "pilot freq = "f9.0:" fhz"i:prt 16,T[10]-1000
47: fnt
48: ret
49:
50:
51: "group carrier leak measurement":
52: dsp "group carrier leak measurement"
53: clr "3586A"i:cll 'impedance write'(T[3])
54: wrt "3586A","R1B1"
55: for T=0 to 11 by 1
56: T[1]+T[2]*4000+F
57: wrt "3586A","FR","F","HZ"
58: cll '3586A read'(1,25,1,0)
59: cll '3586A read'(5,25,5,0,1)
60: next T
61: spc 3!prt "CARRIER LEAK"
62: spc 1!prt "ch dBm dBm0"i:spc 1
63: for T=0 to 11
64: fnt (2.0*x!f6.1,x!f6.1)prt 16,(T+1)*DCT,DCT,T[4]
65: next T:spc 3!fat
66: ret
67:
68:
69: "impedance write":
70: if p1=0!prt "3586A",T[1]+T[2]*1e3+T[20]
71: if p1=2!prt "3586A",T[1]+T[2]*1001+124+T[20]
72: if p1=1!prt "3586A",T[1]+T[2]*1001+135+T[20]
73: ret
74:

```

```

3586A,B PILOT-CARRIER LEAK TEST

Z= 75 ohms
INVERTED CHANNEL
TLP= -21.4dbm

GROUP PILOT

      dBm  dBm0
      -41.6 -20.2

pilot freq =
      84.080 khz

CARRIER LEAK

ch    dBm  dBm0
  1   -77.3 -55.9
  2   -81.2 -59.8
  3   -76.8 -55.4
  4   -80.5 -59.1
  5   -76.1 -54.7
  6   -79.9 -58.5
  7   -75.5 -54.1
  8   -79.2 -57.8
  9   -74.8 -53.4
 10   -78.5 -57.1
 11   -74.0 -52.6
 12   -77.7 -56.3

```

```

75:
76: "3586A read":
77: for k=1 to p1!fat (prt k!f6.1"3586A"i:prt k
78: 0+p4!for p1 to p1!fat (prt k!f6.1"3586A"i:prt k
79: if abs(p4-p1)/p3!fat k-2
80: if p4/9001999+p4
81: if p4/-9001-999+p4
82: ret
83:
84:
85: "3586A amp freq read":
86: for k=1 to p1!fat (prt k!f6.1"3586A"i:prt k
87: 0+p4+p5!for p1 to p1!fat (prt k!f6.1"3586A"i:prt k
88: if abs(p4-p1)/p3!fat k-2
89: if p4/9001999+p4
90: if p4/-9001-999+p4
91: ret
92: end
+29596

```



3336A, B & C S/LG Remote Operation

Control Modes

All necessary functions on the HP 3336 can be controlled from the HP-IB. This not only includes the programming of frequency, amplitude and phase, but it also includes modulation on/off, all sweep parameters, amplitude calibration, and self-test. Because the MODIFY, sweep modification ($\Delta f \times 2$, $\Delta f \div 2$), MKR—CF and CLEAR-ENTRY keys are strictly for bench use, they are not programmable.

In addition, store and recall operations can be initiated by program command through the bus. Although the storage locations 0 through 9 cannot be loaded directly from the bus, operating and signal parameters may be programmed first on the front panel and then stored in memory via a bus command. Using internal memory when the 3336 is controlled via HP-IB can simplify programming and speed execution time for a series of tests where a large number of parameters are changed for each test.

The contents of registers 0 through 9 cannot be directly interrogated by the bus. However, if the register contents are recalled to the front panel of the 3336, the instrument state may be communicated by using the TALK mode. This feature is explained next.

Learn Mode

The 3336 has a TALK mode which allows the instrument to output one ASCII coded parameter at a time upon interrogation by the controller. Some products which have a talk mode similar to this refer to it as a "learn" mode. Some of these "learn" modes output the full instrument condition by sending an uninterrupted string of ASCII characters. For signal sources, where often the only parameter which may change from one test to the next is frequency, the complexity of system programming is not so great as to require the full "learn" mode capability.

Local lockout can be initiated via the bus to protect from accidental front panel operation.

Programming with the 9825A Calculator

The following basic examples are provided to assist the operator in developing programs for the Model 3336 in an HP-IB system which uses the HP Model 9825A Calculator as the system controller. The calculator must be equipped with a General I/O ROM and an HP-IB Interface set to select code 7. The calculator (controller) normally holds the REN line true, unless the "lcl 7" (local) command is sent. REN may be returned to the true state by the "rem 7" (remote) command.

Example 1: This is a basic program statement which accomplishes the following:

```
Address the controller to talk
Address the 3336A, B or C to listen
Send Program Data:
  Frequency: 12.345678910 MHz
  Output Impedance: 75Ω
  Output Level: -71.01 dBm
  AM Modulation: ON
```

This portion places the Bus in the command mode, addresses the calculator to talk and the 3336 to listen

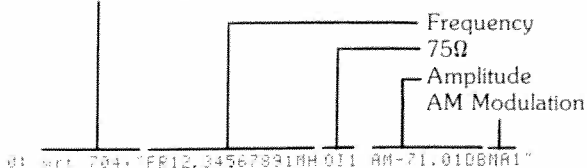

The last parameter programmed can be changed without sending the parameter mnemonic. For example, following the program string above, AM may be turned off by using 'MA0'

Example 2: This program sets up sweep parameters and initiates a single sweep.

```
Address the controller to talk
Address the 3336A to listen
Send Program Data:
  Function: Sine
  Amplitude: 10 dB
  Start Frequency: 64 kHz
  Stop Frequency: 108 kHz
  Marker Frequency: 104.08 kHz
  Sweep Time: 2 seconds
  Start Single Sweep
```

NOTE: To start a single sweep, the mnemonic "SS" must be sent twice. The first "SS" sets the 3336 to the Start frequency, and the second "SS" starts the sweep.

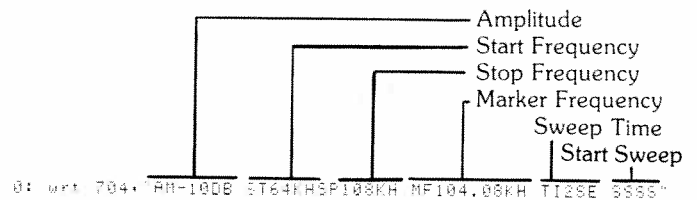

Example 3: This example checks the "Require Service" status of the 3336 and if it did request service, determines the reason.

```
01: wrt 704, "MS0A
M70BST1KHSP85MH
T15SESC"
1: wait 1000
2: rds(704)+S
3: if bit(6,S)=1
  |prt "Request
  |Service";asb 5
4: dsp "Proceed
  |with Program";
  |stp
5: if bit(0,S)=1
  |prt "Program
  |Error";wrt 704,
  |"IER";red 704,E
6: if E=1;prt
  |"Parameter out
  |of bounds"
7: if E=2;prt
  |"Invalid delime
  |ter"
8: if E=3;prt
  |"Frea too high"
9: if E=4;prt
  |"Sweep time
  |invalid"
10: if E=5;prt
  |"Amtd error"
11: if E=6;prt
  |"Sweep paramete
  |r error"
12: if E=7;prt
  |"Unrecognizable
  |mnemonic"
13: if E=8;prt
  |"Unrecognizable
  |data character"
14: if E=9;prt
  |"Option does
  |not exist"
```

1. Enables all service request conditions.
2. Program data contains an error. Stop frequency (SP15KH) is too high.
3. Wait statement allows time for sweep to start before reading status.
4. Read status byte from the 3336 and place in the calculator variable "S."
5. If bit 6 of the status byte = 1, the 3336 did request service. Go to subroutine to determine the reason.
6. Programming continues at this point if the 3336 did not request service or upon returning from the subroutine.
7. If service request resulted from a program string error, interrogate the 3336 to determine the error code and place in the calculator variable "E."
8. Determine the nature of the program error.

```

15: if bit(1, S)=1;prt "SWEEP
    stopped"
16: if bit(2, S)=1;prt "Sweep
    started"
17: if bit(3,S); 9
    prt "System
    failure"
18: if bit(5,S);
    prt "Sweeping"
19: if bit(7,S);
    prt "Busy"
20: ret _____10

```

9. Determine other reason for service request and if "Sweeping" or "Busy" flags were true.
10. Return from subroutine.

```

Request Service
Program Error
Sweep Parameter
Error
System Failure
Request Service
Sweep Started
Sweeping

```

11. Printer records the results of the serial poll.
12. If the program string were corrected to make all data valid, this printout would result from the above program.

Example 4: The 3336 can be set up manually to the optimum parameters needed for the test to be performed, then the calculator can interrogate the 3336 to determine and record these parameters. This example program interrogates

Frequency: IFR
Amplitude: IAM

```

0: wrt 704,"IFR"
  ;red 704,F;fxd
  6
1: prt "Freuenc
  y=",F,"HZ"
2: wrt 704,"IAM"
  ;red 704,A
3: prt "Amplitud
  e=",A,"DB"

```

Line 0 Write statement interrogates Function; read statement address 3336 to talk, calculator to listen, and places data in variable W; "fxd 6" fixes six decimal places.

Line 1 Because only numerical data can be placed in the variables, print statements may include in quotes the parameter interrogated.

Lines 2-7 Other parameters are interrogated. Frequency is always returned in Hz and amplitude in dBm.

```

Frequency=
20010000.000000
HZ
Amplitude=
-72.990000
DB

```

This printout results from the above program.

If the calculator is equipped with a String Variable ROM, the interrogate program may be changed to the following. Because string variables accept both alpha and numeric characters, the resulting printout includes the mnemonics and delimiters (units).

```

0: dim F#[50],
  A#[50]
1: wrt 704,"IFR"
  ;red 704,F#;
  prt F#
2: wrt 704,"IAM"
  ;red 704,A#;
  prt A#

```

1. Dimension a string variable for each parameter you want to interrogate. The dimension number (in brackets) is the number of spaces assigned to the variable.

```

FR00100000.000HZ
AM-0000010.000DB

```

2. This printout results when string variables are used.

Example 5: The 3336 can be made to sweep amplitude (in steps) if a for/next statement is used in the calculator program. It is recommended that the upper and lower amplitude limits selected be on the same range because irregularities in the sweep will occur if the attenuator relays are switched.

```

0: wrt 704,"FR1K
  H AM3DB"
1: for I=3 to 7
  by .1;wrt 704,
  I,"DB"
2: next I
3: for I=0 to 3
  by -.1;wrt 704,
  I,"DB"
4: next I
5: sto 1

```

Line 1 The sweep limits (-3 to 0 dBm) are on the same range. The sweep increment is in .1 V steps. Because amplitude was the last parameter programmed, the write statement does not require the "AM" mnemonic.

Line 2 The calculator returns to Line 1 until I=7, then proceeds to Line 3.

Line 3 The sweep decrement is also in .1 dB steps.

Line 5 Return to Line 1 to continue sweeping.

The sweep speed is determined by calculator and 3336 data transfer and processing times. If a slower sweep time is desired, wait statements may be added before the "next I" statements.

HP-IB Programming Codes

Model 3336A/B/C Synthesizer/Level Generator HP-IB Programming Codes (ASCII Characters)

<u>F</u> requency	FR or FF	<u>A</u> mplitude <u>B</u> lanking	AB
<u>H</u> ertz	HZ or HH	Off	0
<u>K</u> ilo- <u>H</u> ertz	KH	On	1
<u>M</u> ega- <u>H</u> ertz	MH		
<u>A</u> Mplitude	AM	<u>M</u> odulation, <u>A</u> mplitude	MA
<u>d</u> Bm	DB	Off	0
		On	1
<u>P</u> Hase	PH	<u>M</u> odulation, <u>P</u> hase	MP
<u>D</u> Egrees	DE	Off	0
		On	1
Sweep <u>S</u> Tart Frequency	ST		
Sweep <u>S</u> top Frequency	SP	<u>F</u> ast <u>L</u> eveling	FL
Sweep <u>M</u> arker <u>F</u> requency	MF	Off	0
		On	1
Sweep <u>T</u> ime	TI	<u>S</u> to <u>R</u> e Program	SR
<u>S</u> Econds	SE	Location	0 to 9
<u>S</u> weep <u>M</u> ode	SM	<u>R</u> Ec <u>A</u> ll Program	RE
Linear	1	Location	0 to 9
Logarithmic	2		
Data Transfer <u>M</u> o <u>D</u> e	MD	<u>M</u> ask <u>S</u> ervice Request	MS
Normal	1	Mask Code	@ thru 0
48 Character Buffer	2		
<u>O</u> utput <u>I</u> mpedance Select	OI	<u>I</u> nterrogate	
3336A		<u>F</u> requency	IFR
75 ohm unbal	1	<u>A</u> Mplitude	IAM
150 ohm bal	2	<u>P</u> Hase	IPH
600 ohm bal	3	Sweep <u>S</u> Tart Freq	IST
3336B		Sweep <u>S</u> top Freq	ISP
75 ohm unbal	1	Sweep <u>M</u> arker Freq	IMF
124 ohm bal	2	Sweep <u>T</u> ime	ITI
135 ohm bal	3	Sweep <u>M</u> ode	ISM
600 ohm bal	4	Fast Leveling	IFL
3336C		Output Impedance	IOI
50 ohm unbal	1	Amplitude Blanking	IAB
75 ohm unbal	2	Amplitude Modulation	IMA
<u>A</u> ssign Zero <u>P</u> hase	AP	Phase Modulation	IMP
<u>S</u> tart <u>S</u> ingle Sweep	SS*	<u>E</u> Rror Codes	IER
<u>S</u> tart <u>C</u> ontinuous Sweep	SC	1. Entry out of bounds	
		2. Invalid delimiter	
		4. Sweep time too long or too short	
		6. Sweep bandwidth too small; start frequency greater than stop frequency (Log sweeps)	
		7. Unrecognizable mnemonic	
		8. Unrecognizable data character	

* Start Single code must be sent twice "SSSS". The first "SS" resets the sweep to start conditions and the second "SS" starts the sweep.

Parameter Interrogation

When the 3336 is interrogated, the data returned is formatted as follows:

Parameter Interrogated	Program Code	Format
Frequency	IFR, IFF	FR DDDDDDDD.DDD HZ CR LF&EOI or FR DDDDD.DDDDDD HZ CR LF&EOI
Amplitude	IAM	AM 000000DD.DDD DB CR LF&EOI or AM -00000DD.DDD DB CR LF&EOI
Phase	IPH	PH 00000DDD.DDD DE CR LF&EOI or PH -0000DDD.DDD DE CR LF&EOI
Sweep Time	ITI	TI 000000DD.DDD SE CR LF&EOI
Output Impedance	IOI	OI D CR LF&EOI
Sweep Mode	ISM	SM D CR LF&EOI
Fast Leveling	IFL	FL D CR LF&EOI
Amplitude Blanking	IAB	AB D CR LF&EOI
Amplitude Modulation	IMA	MA D CR LF&EOI
Phase Modulation	IMP	MP D CR LF&EOI
Error Codes	IER	ER D CR LF&EOI

Codes used in these examples:

D = ASCII digits 0 thru 9

CR = ASCII Carriage Return

LF&EOI = ASCII Line Feed concurrent with End of Identify Line True

All other characters are the actual ASCII characters returned. Spaces are not sent but are inserted in these examples for operator clarity.

Other frequencies interrogated are formatted exactly like the example except that "FR" changes to the program code of the interrogated parameter ("ST" for Sweep Start Frequency, for example).

Status Byte

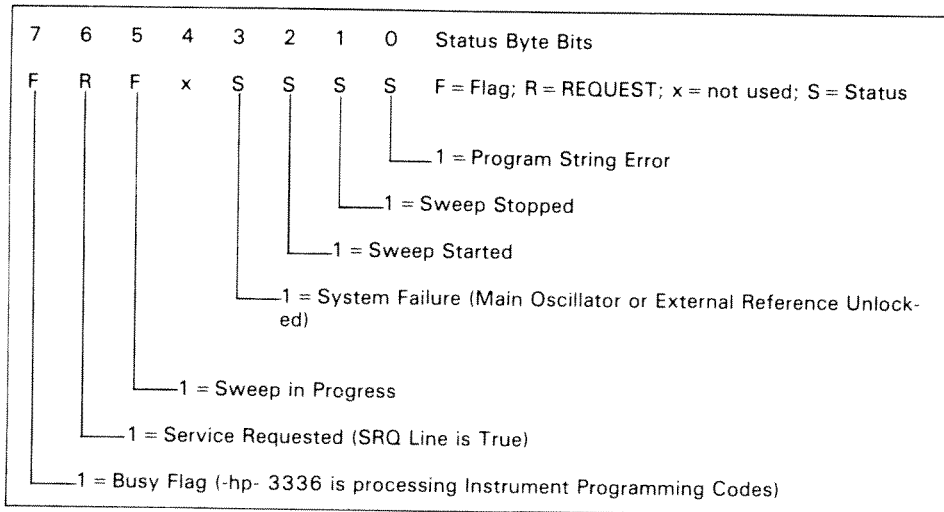

The instrument conditions associated with bits 0 thru 3 can, when enabled, cause a service request. The instrument programming codes to mask or unmask these bits are:

Instrument Programming Codes	Bit 3 System Fail	Bit 2 Sweep Start	Bit 1 Sweep Stop	Bit 0 Program Error
MS + @	Mask	Mask	Mask	Mask
A	Mask	Mask	Mask	Enable
B	Mask	Mask	Enable	Mask
C	Mask	Mask	Enable	Enable
D	Mask	Enable	Mask	Mask
E	Mask	Enable	Mask	Enable
F	Mask	Enable	Enable	Mask
G	Mask	Enable	Enable	Enable
H	Enable	Mask	Mask	Mask
I	Enable	Mask	Mask	Enable
J	Enable	Mask	Enable	Mask
K	Enable	Mask	Enable	Enable
L	Enable	Enable	Mask	Mask
M	Enable	Enable	Mask	Enable
N	Enable	Enable	Enable	Mask
O	Enable	Enable	Enable	Enable

Abridged Description of the HP-IB

The Hewlett-Packard Interface Bus (HP-IB) consists of sixteen active signal lines that are used to interconnect up to fifteen devices (e.g., instruments). The sixteen signal lines are categorized according to function. The categories are DATA, HANDSHAKE and GENERAL INTERFACE MANAGEMENT lines.

DATA LINES

Eight DATA lines are used to carry instrument addresses, instrument control instructions, measurement results and instrument status information in bit parallel, byte serial form. Ordinarily, a seven bit ASCII code represents each byte of DATA. The eighth bit is available for parity checking. Data is sent over the DATA lines in both directions.

HANDSHAKE (DAV, NRFD, NDAC)

Data is transferred between devices using an interlocked "handshake" technique. This method causes the data to be moved at a rate determined by the slowest device involved in the transfer. The HANDSHAKE LINES coordinate the asynchronous data transfer by communicating the status of the transfer to the device sending the data (Talker), the device receiving the data (Listener) and the device controlling the transfer (Controller).

GENERAL INTERFACE MANAGEMENT LINES

These five lines operate independently and in conjunction to send Bus Management Messages to the devices connected to the HP-IB. Each line has a precise definition that is either sent or not sent depending on the truth state of the line. The lines are defined as follows:

- Attention (ATN) – Identifies ASCII characters on the DATA lines as a command (command mode) or as data to be transferred (data mode).
- Remote Enable (REN) – In conjunction with the ATN Line, places the instrument in the Remote mode.
- End or Identify (EOI) – Indicates the last character of a multi-byte data message. Also used with Attention Line to conduct a parallel poll.
- Service Request (SRQ) – A device on the bus uses this line to request service from the controller.
- Interface Clear (IFC) – Halts all bus activity.

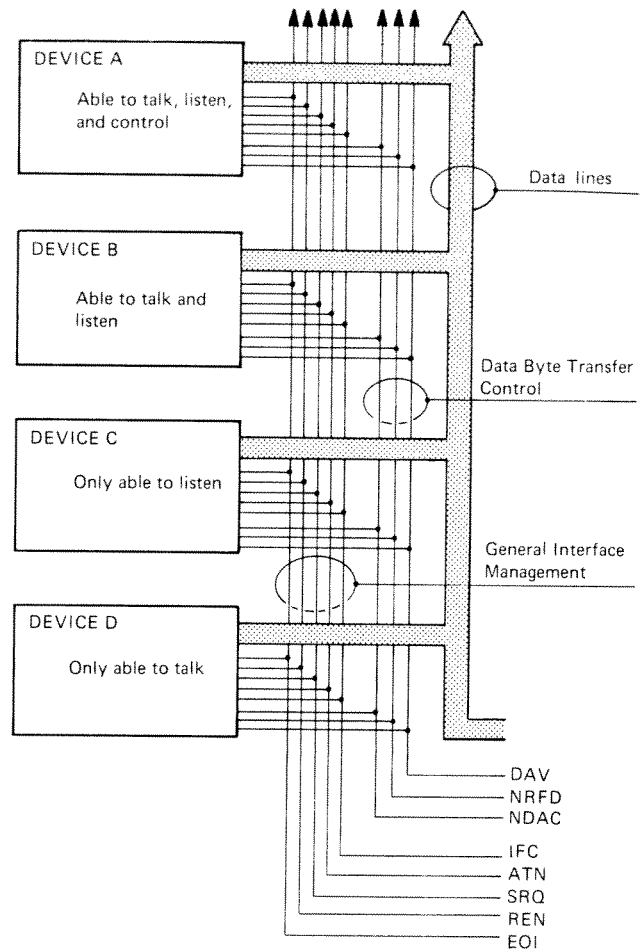

Chapter VI

Technical Description

3586A, B & C SLM

The 3586A, B, or C Selective Level Meter is a very sensitive, highly selective, dual conversion receiver with microprocessor control. Fractional-N synthesized local oscillator circuitry, unique to HP, provides .1 Hz resolution and synthesizer accuracy and stability. (See page 43 for a theoretical discussion of the fractional-N concept.) An RMS detector combined with an automatic level calibrator and accurate input level attenuator allow $\pm .2$ dB accuracy over most of the frequency and level range.

Input MUX

The input multiplexer provides impedance selection, balancing transformers for balanced input impedances, and sets the impedance into the attenuator for all inputs.

Autoranging

The input level is detected and both RF gain or loss and IF gain or loss are automatically set for best signal to noise ratio. The IF gain establishes the "FULL SCALE," or top of range level. In 10 dB RANGE, the most linear 10 dB portion of the logger range is chosen for best amplitude accuracy. In 100 dB RANGE, the entire logger dynamic range is used. The FULL SCALE setting can be manually entered; however, RF gain or loss is always chosen automatically.

Automatic Calibration

The first local oscillator is mixed back to the programmed input frequency in the tracking mixer and is accurately set to -40 dBm $\pm .05$ dB to provide a calibration signal at three minute intervals or when programmed. This continual updating compensates for level drift to provide $\pm .2$ overall level accuracy without the need for manual calibration.

Tracking Output

The tracking mixer output is also amplified to 0 dBm $\pm .5$ dB to provide rear panel output at the input signal frequency for frequency response measurements of networks.

Dual Conversion

Double conversion assures maximum image and intermodulation performance combined with optimum selectivity and sensitivity. The first local oscillator tunes the Selective Level Meter and is actually a 50-82 MHz synthesizer using HP's unique fractional-N technology (see page 43). 0.1 Hz resolution precise frequency setting and excellent frequency stability is the result. The second local oscillator is fixed near 50 MHz and converts the signal to the 15,625 Hz second IF frequency. IF crystal filters provide the selectivity including 60 dB carrier rejection, 75 dB adjacent channel rejection, and 50 dB carrier rejection in the 20 Hz pilot filter. All of the filter responses are flat-topped for best level accuracy.

RMS Detector/Logger

The true RMS detector and logger circuitry is used for detection of the selective and SSB channel mode signals and noise, and also wideband mode noise for baseband testing. True RMS detection allows accurate measurements of both signal level and all types of noise with crest factors up to 5:1. The log amplifier takes advantage of HP's integrated circuit technology to provide excellent log accuracy at low cost.

SSB Channel Demod and Impairments

Upper or lower sideband demodulation is provided to either a speaker or 600 ohm headphone audio output. The headphone output can be used for additional voice frequency measurements with external instruments.

Optional voice frequency transmission impairment measurement circuitry includes a selection of impairment measurements not previously available on a selective level meter. The use of direct weighting filters in Option 003 provide more accurate weighted noise measurements when compared with equivalent noise measurements.

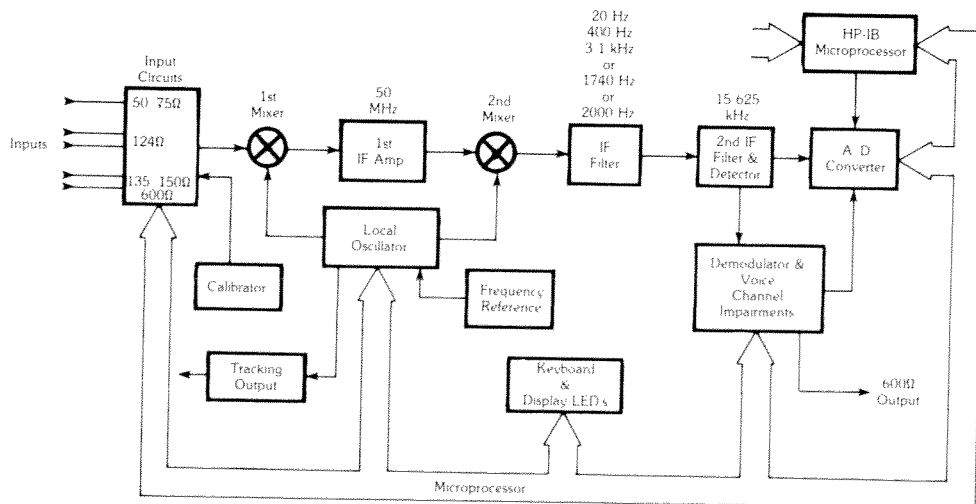

Figure 6-1 3586A,B & C Selective Level Meter

3336A, B & C S/LG

Single Phase-lock Loop Replaces Multiple Loops

Fractional-N synthesis, a technique first used in the 3335A Synthesizer/Level Generator and later the 3325A Synthesizer/Function Generator, is the largest single cost reducing factor in the 3336A, B, & C. In fact, fractional-N made it possible to build the 3336 with one phase-lock loop. And one loop costs significantly less than the many used in conventional synthesizers. Further, integration of the fractional-N control circuitry resulted in more cost savings.

To see how fractional-N works, we will review the traditional +N Phase Lock Loop method of indirect synthesis. The phase of the VTO output in Figure 2 is compared to the phase of the reference. Any difference is corrected by generating a dc correction voltage which retunes the VTO.

To obtain different frequencies, a +N Counter is added as shown in Figure 3. The N number is programmed such that the counter output is always equal to the frequency of the reference. The only limitation is that we can lock only to integral multiples of the reference frequency. To get more resolution, more loops are added.

The synthesizer shown in Figure 4 uses four phase lock loops, each providing two digits. The outputs are then sequentially summed to achieve the desired resolution. Costs are also sequentially summed!

Let's assume the desired output is 1.01 MHz. What we would really like to do is divide by 10.1 so the phase detector would still see 100 kHz at both inputs. Conceptually this is what fractional-N does.

Let's open the loop and assume the VTO is operating at 1.01 MHz. The task of fractional-N will then be to create a dc feedback voltage that will cause the VTO to continue to operate at 1.01 MHz when the loop is closed.

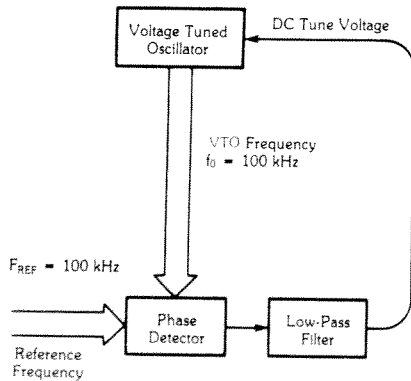

Figure 6-2 Basic Phase Locked Loop Used to Produce Single Frequencies

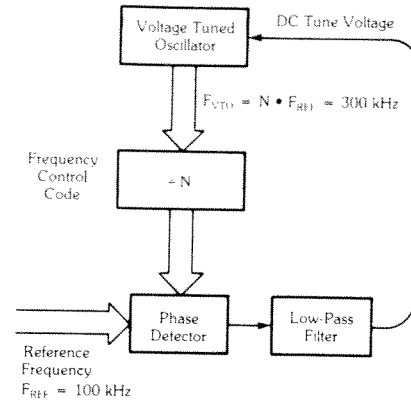

Figure 6-3 A Phase Lock Loop With a Divide-by-N Element to Produce a Range of Frequencies in Steps Equal to Integral Multiples of the Reference Frequency

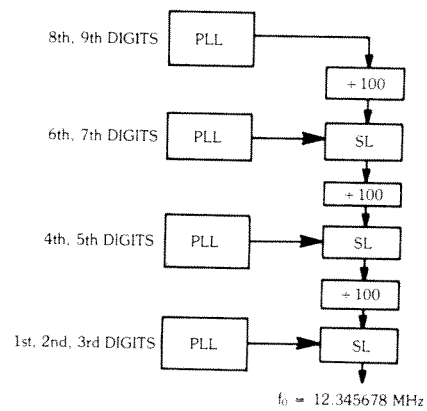

Figure 6-4 Synthesizer Using Four Phase Locked Loops

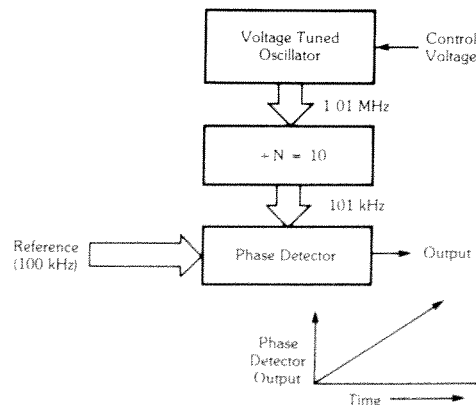

Figure 6-5 The Basic Block Diagram of an N Step Loop in an Open Loop Condition

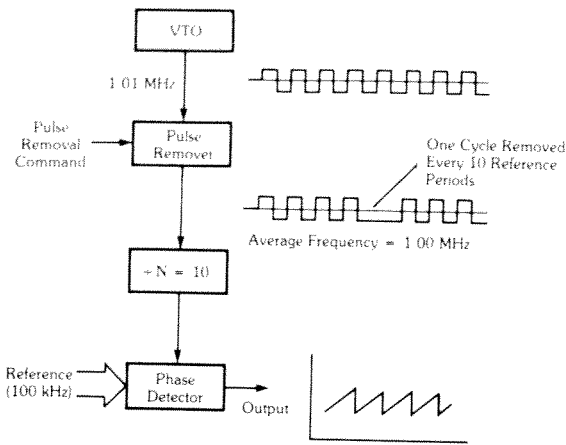

Figure 6-6 The Basic Block Diagram of a Modified N Step Loop With a Pulse Remover Added to Allow the VTO to Operate at a Fractional Frequency

The + N counter is set to the closest integer (10), as shown in Figure 5. Since the phase of the 101 kHz is constantly advancing on the phase of the REF, the phase DET output is ever increasing. We want the output of the + N counter to be 100 kHz, but this will require the input to the counter to be 1 MHz. A circuit element is added to do this.

In Figure 6 we see the pulse train out of the VTO, the new circuit element (a pulse remover) and the pulse train out of the pulse remover. Upon command from the microprocessor, the pulse remover will remove one of the pulses.

If a pulse is removed after every 100 cycles of the VTO, the average frequency, as seen on a counter, will be 1 MHz. The average frequency out of the phase DET will in turn be 100 kHz. However, the instantaneous frequency will be 101 kHz.

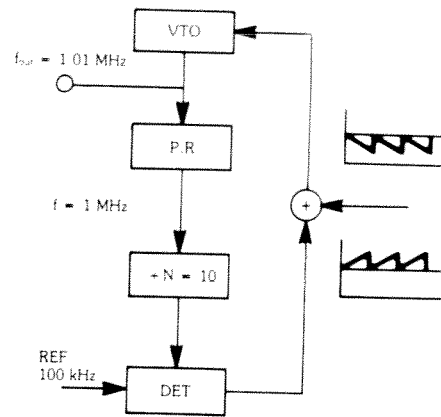

Figure 6-7 Adding an Opposing AC Voltage From Processor Controlled D/A

The phase detector output will increase with time as it sees the f_{inst} of 101 kHz. When the pulse is removed, it will suddenly be back in phase with the reference. The dc value of the phase DET output is the correct dc to lock the VTO to 1.01 MHz. The only remaining task is to remove the ac component. Filtering would not remove enough ac without reducing switching speed to an unacceptable level.

What is done is to add an equal and opposing ac voltage from a processor controlled D/A converter as shown in Figure 7. The output of this is then filtered to further "clean up" the dc correction voltage. This will then lock the VTO to 1.01 MHz.

This is a brief description of fractional-N. More detailed descriptions are found in the 3336A, B, C Operating and Service Manual.

Amplitude Leveling

The extremely accurate amplitude regulation of the 3336 Synthesizer/Level Generator is accomplished using a unique internal leveling technique. The block schematic is shown in Figure 6-9. Cascading a power detector for high accuracy and a peak detector for fast responses in a negative feedback loop is the heart of the 3336A, B & C. It has two distinct leveling modes: Fast Leveling OFF and ON. In Fast Leveling OFF, only the power detector is in the leveling loop and the amplitude settling time of the loop is ≈ 250 ms. When Fast Leveling is ON (switches set opposite to that shown on the block diagram), the power detector and the peak detector are in the leveling loop and the amplitude settling time is reduced to ≈ 1 ms, without sacrificing any amplitude accuracy. The output power is compared to, and driven until it is equal to a reference voltage. If the reference voltage changes, the output power must also change. The reference voltage is set to specific values, over a 9.99 dB range, that are proportional to the programmed output amplitude. For output amplitudes more than 9.99 dB below full output, attenuations of 10 dB through 70 dB in 10 dB steps are added, resulting in a 79.99 dB dynamic range.

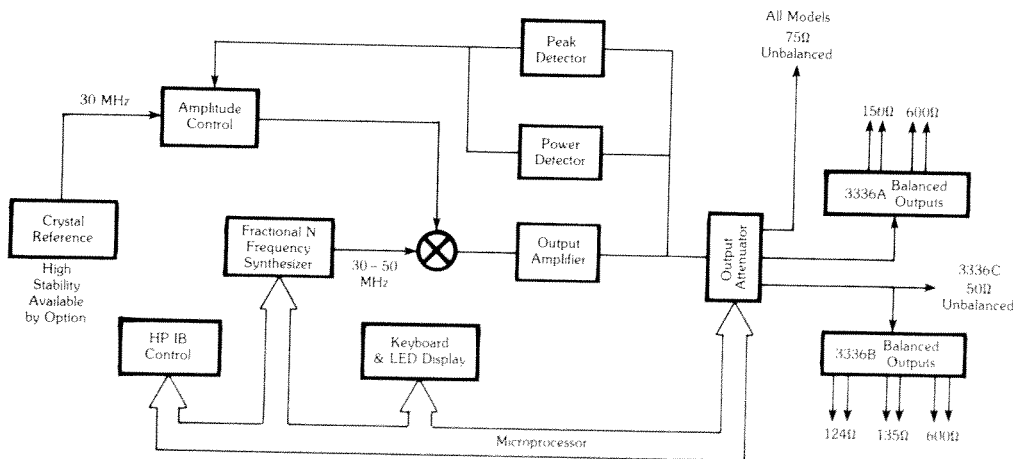

Figure 6-8 3336A,B & C Synthesizer/Level Generator

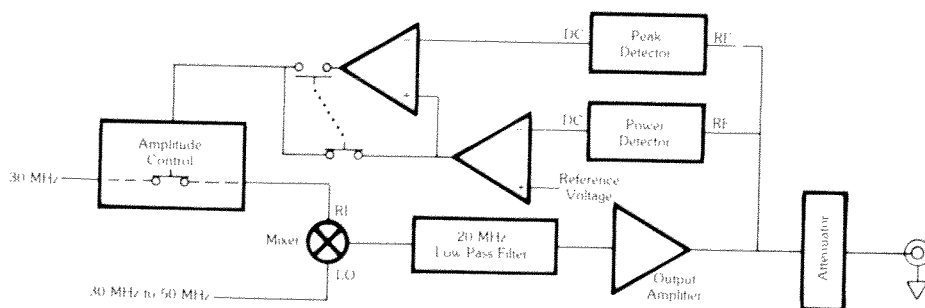
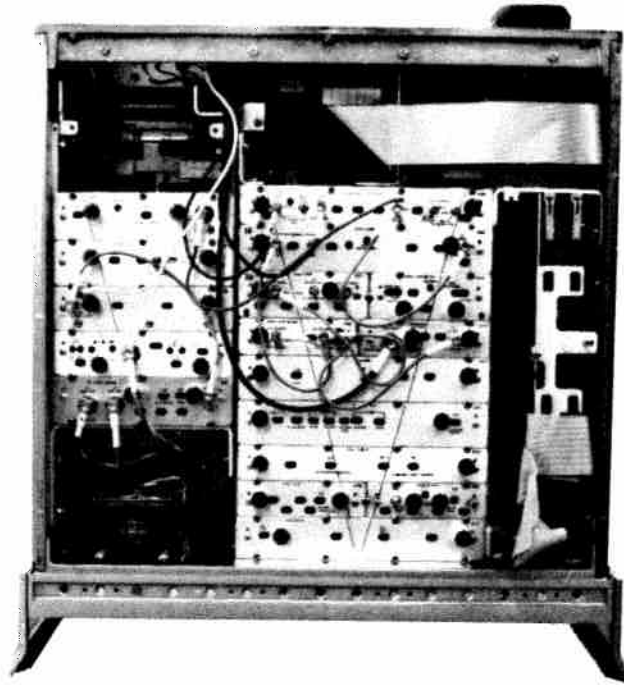

Figure 6-9 3336A,B & C Synthesizer/Level Generator Amplitude Regulator

Chapter VII

Serviceability



Serviceability has been designed into both the 3336A, B & C, and 3586 from their concept. Serviceability features include amplitude auto-cal, internal SELF-TEST function, digital signature analysis (SA) for troubleshooting the controller and other digital circuitry, easily accessible printed circuit boards and test points and extensive component labeling.

Functional Verification Tests

As a result of today's complex instruments, the cost of performance testing has increased substantially. To reduce costs, one may elect to use the functional verification tests provided in the Operating and Service Manuals. These tests, when combined with self-test capability, will give the operator a high degree of confidence that the instrument is working properly, while consuming little test time. Complete performance test information is still included for 100% performance verification when required.

Signature Analysis

Signature Analysis (SA) is another time-saving service feature. The "signature" are the residue of lengthy data streams, measured at logic test modes.

The basic ingredients of Signature Analysis (SA) are "data compression" and "circuit generated." Both of these features exist, to some degree, in transition counting, but in Signature Analysis they are refined in a manner that affords greater overall performance in terms of locating faults in complex digital circuitry.

"Data compression" is achieved in the Signature Analyzer by probing a logic test node from which data is input for each and every circuit clock cycle that occurs within a circuit controlled time window. Within the Signature Analyzer is a 16-bit feedback shift register into which the data is entered in either its true or

complement logic state, according to previous data-dependent register feedback conditions. In all, there are $2^{16} = 2^4)^4$, and become a "signature." This signature is then a characteristic number representing time dependent logic activity during a specified measurement interval for a particular circuit node. Any change in the behavior of this node (e.g., even a transition that is one clock cycle late or skewed with respect to the clock) will produce a different signature, indicating a probable circuit malfunction. A single logic state change on a node is all that is necessary to produce a meaningful signature. And, because of the compression algorithm chosen, measurement intervals exceeding 2^{16} clock cycles will still produce valid, repeatable signatures.

A signal that causes the node to produce a signature is the "stimulus." In SA, the stimulus is supplied by the product itself. By doing this, a controlled environment can be created wherein selected circuit portions can be tested independently of others, while maintaining full dynamic operation. Additionally, synchronization and measurement intervals for the Signature Analyzer can be controlled by the product under test. In microprocessor systems, the stimulus is nothing more than a program (generally in ROM) that exercises the rest of the system. Taking advantage of the data manipulative capabilities of microprocessors, generating good stimulus patterns that exercise individual devices in the product is usually not very difficult. Indeed, it is often true that the more complex system, the greater the benefit derived from using SA. The technique can take much of the uncertainty out of servicing microprocessor and other bus structured products.

For more detailed information, see HP Application Note AN 222, "A Designer's Guide to Signature Analysis," and HP Journal, May 1977, "Signature Analysis: A New Digital Field Service Method."

For more information, call your local HP Sales Office or nearest Regional Office: • Eastern (301) 258-2000; • Midwestern (312) 255-9800; • Southern (404) 955-1500; • Western (213) 877-1282; • Canadian (416) 678-9430. Ask the operator for instrument sales. Or write Hewlett-Packard, 1501 Page Mill Road, Palo Alto, CA 94304. In Europe: Hewlett-Packard S.A., 7, rue du Bois-du-Lan, P.O. Box, CH 1217 Meyrin 2, Geneva, Switzerland. In Japan: Yokogawa-Hewlett-Packard Ltd., 29-21, Takaido-Higashi 3-chome, Sugnam-ku, Tokyo 168.

